

# USER'S MANUAL

Rev. 05/2022

# REVO S IFH 1PH

From 30 to 40A

010

M-RS1-IFH-30-40



**CD Automation S.r.l.**

Via Picasso, 34/36 - 20025 Legnano (MI)- Italy

Tel. +39 0331 577479 - Fax +39 0331 579479

E-mail: [info@cdautomation.com](mailto:info@cdautomation.com) - Web: [www.cdautomation.com](http://www.cdautomation.com)



# Declaration of conformity

Declaration of conformity - Dichiarazione di Conformità



**PRODUCT MANUFACTURER / PRODUTTORE:**



**CD Automation S.R.L.**  
Controllers, Drives & Automation

Via Picasso, 34/36 - 20025 Legnano (MI)- Italy  
P.I. 08925720156 -Tel. +39 0331 577479 - Fax +39 0331 579479  
E-mail: info@cdautomation.com - Web: www.cdautomation.com

**Declare that the product / Dichiaro che il prodotto:**

**Revo S-IFH 1PH 30-40A**

PRODUCT DESCRIPTION: Electric power control  
SCOPE OF APPLICATION: Thermal control process  
DESCRIZIONE DEL PRODOTTO: Unità di controllo potenza elettrica  
UTILIZZO: Controllo processi termici

**FULFILLS THE REQUIREMENTS OF THE STANDARD:**

Electrical safety Standard EN60947-1: 2007 + A1 2011, A2 2014  
EN60947-4-3: 2014  
Generic Emission standard EN60947-4-3: 2014 Group 1 Class A emissions  
Generic Immunity standard EN60947-4-3: 2014 Industrial Immunity

**SODDISFA I REQUISITI DELLA NORMA:**

Specifica di sicurezza EN60947-1: 2007 + A1 2011, A2 2014  
EN60947-4-3: 2014  
Specifica sulle emissioni EN60947-4-3: 2014 gruppo 1 emissioni classe A  
Specifica sulle Immunità EN60947-4-3: 2014 Immunità industriale

CDAutomation declares that the products above mentioned are conforming to the directive  
CDAutomation dichiara che i prodotti sopra menzionati sono conformi alla direttiva  
Bassa Tensione (low Voltage) **EMC directive updated 2014/30/EU,**  
**Low Voltage Directive updated 2014/35/EU**

Issued on: 20/03/2017  
Data di emissione: 20/03/2017

Amministratore Unico e  
Legale Rappresentante

Simone Brizzi



# Declaration of conformity

Declaration of conformity - Dichiarazione di Conformità



**PRODUCT MANUFACTURER / PRODUTTORE:**



**CD Automation S.R.L.**  
Controllers, Drives & Automation

Via Picasso, 34/36 - 20025 Legnano (MI)- Italy  
P.I. 08925720156 -Tel. +39 0331 577479 - Fax +39 0331 579479  
E-mail: info@cdautomation.com - Web: www.cdautomation.com

**Declare that the product / Dichiaro che il prodotto:**

**Revo S-IFH 1PH 30-40A**

PRODUCT DESCRIPTION: Electric power control  
SCOPE OF APPLICATION: Thermal control process  
DESCRIZIONE DEL PRODOTTO: Unità di controllo potenza elettrica  
UTILIZZO: Controllo processi termici

**FULFILLS THE REQUIREMENTS OF THE STANDARD:**

Electrical safety Standard EN60947-1: 2007 + A1 2011, A2 2014  
EN60947-4-3: 2014  
Generic Emission standard EN60947-4-3: 2014 Group 1 Class A emissions  
Generic Immunity standard EN60947-4-3: 2014 Industrial Immunity

**SODDISFA I REQUISITI DELLA NORMA:**

Specifica di sicurezza EN60947-1: 2007 + A1 2011, A2 2014  
EN60947-4-3: 2014  
Specifica sulle emissioni EN60947-4-3: 2014 gruppo 1 emissioni classe A  
Specifica sulle Immunità EN60947-4-3: 2014 Immunità industriale

CDAutomation declares that the products above mentioned are conforming to the directive  
CDAutomation dichiara che i prodotti sopra menzionati sono conformi alla direttiva  
Bassa Tensione (low Voltage) **EMC directive updated 2014/30/EU,**  
**Low Voltage Directive updated 2014/35/EU**

Issued on: 07/03/2022  
Data di emissione: 07/03/2022

Amministratore Unico e  
Legale Rappresentante







Simone Brizzi

# Important warnings for safety

This chapter contains important information for the safety. The not observance of these instructions may result in serious personal injury or death and can cause serious damages to the Thyristor unit and to the components system included.

*The installation should be performed by qualified persons.*

In the manual are used symbols to give more evidence at the notes of safety and operativity for the attention for the user:

	This icon is present in all the operational procedures where the Improper operation may result in serious personal injury or death by Electrical Shock Hazard Symbol (a lightning bolt in a triangle) precedes an electric shock hazard CAUTION or WARNING safety statement.
	Warning or Hazard that needs further explanation than the label on unit can provide. Consult User's Guide for further information.
	Unit is compliant with European Union directives. See Declaration of Conformity for further details on Directives and Standards used for Compliance.
	If available, unit is a Listed device per Underwriters Laboratories. It has been investigated to ANSI/UL® 508 standards for Industrial Control Switches and equivalent to CSA C22.2 #14. For more detail search for File E231578 on www.ul.com
	ESD Sensitive product, use proper grounding and handling techniques when installing or servicing product.
	Do not throw in trash, use proper recycling techniques or consult manufacturer for proper disposal.

A **"NOTE"** marks a short message to alert you to an important detail.

A **"CAUTION"** safety alert appears with information that is important for protecting your equipment and performance. Be especially careful to read and follow all cautions that apply to your application.





















A **"WARNING"** safety alert appears with information that is important for protecting you, others and equipment from damage. Pay very close attention to all warnings that apply to your application.

## Safety notes

 **WARNING!** To avoid damage to property and equipment, injury and loss of life, adhere to applicable electrical codes and standard wiring practices when installing and operating this product. Failure to do so could result in damage, injury and death.

 **AVERTISSEMENT!** Pour éviter d'endommager la propriété et l'équipement, les blessures et la perte de vie, respecter les codes électriques en vigueur et les pratiques de câblage standard au moment de l'installation et de l'utilisation de ce produit. Dans le cas contraire, cela peut entraîner la mort, des blessures graves ou des dommages.

-  **WARNING!** All service including inspection, installation, wiring, maintenance, troubleshooting, fuse or other user serviceable component replacement must be performed only by properly qualified personnel. Service personnel must read this manual before proceeding with work. While service is being performed unqualified personnel should not work on the unit or be allowed in the immediate vicinity.
-  **AVERTISSEMENT!** Tous les services, y compris l'inspection, l'installation, le câblage, l'entretien, le dépannage, le remplacement de fusibles ou d'autres composants pouvant être réparés par l'utilisateur, doivent être effectués uniquement par un personnel d'entretien qualifié. Le personnel de service doit lire ce manuel avant d'effectuer tout travail. Pendant que l'entretien est exécuté, tout personnel non qualifié ne doit effectuer de travail sur l'appareil ni se trouver à proximité.
-  **WARNING!** When in use the power controller is connected to dangerous voltages. Do not remove the protective covers without first disconnecting and preventing power from being restored while servicing the unit.
-  **AVERTISSEMENT!** Au moment de l'utilisation, le régulateur de puissance est connecté à des tensions dangereuses. Ne retirer aucun couvercle de protection sans d'abord débrancher l'appareil et ainsi empêcher l'alimentation d'être rétablie pendant l'entretien.
-  **WARNING!** Do not use in aerospace or nuclear applications.
-  **AVERTISSEMENT!** Ne pas utiliser pour les applications aérospatiales ou nucléaires.
-  **WARNING!** The units are not developed to manage capacitive and inductive loads.
-  **AVERTISSEMENT!** Les unités ne sont pas développées pour la conduite de charges capacitatives et inductives.
-  **WARNING!** The power controller's protection rating is IP20 with all covers installed and closed. It must be installed in an enclosure that provides all the necessary additional protections appropriate for the environment and application.
-  **AVERTISSEMENT!** L'indice de protection du régulateur de puissance est de IP20 lorsque les couvercles sont installés et fermés. L'appareil doit être installé dans une enceinte qui assure toute la protection supplémentaire nécessaire pour l'environnement et l'application.
-  **WARNING!** Ground the power controller via the provided protective earth grounding terminal. Verify ground is within impedance specifications. This should be verified periodically.
-  **AVERTISSEMENT!** Mise à la terre du régulateur de puissance par le biais de la borne de prise de terre de protection fournie. Vérifier que la prise de terre est conforme aux spécifications de l'impédance. Cela doit être vérifié périodiquement.
-  **WARNING!** Electric Shock Hazard: when the power controller has been energized, after shutting off the power, wait at least one minute for internal capacitors to discharge before commencing work that brings you in to contact with power connections or internal components.
-  **AVERTISSEMENT!** Risque de décharges électriques: lorsque le régulateur de puissance est mis sous tension, après avoir été éteint, attendre au moins une minute pour que les condensateurs internes se déchargent avant de commencer tout travail incluant le contact avec les connexions électriques ou les composants internes.
-  **WARNING!** The installation must be protected by electromagnetic circuit breakers or by fuses. The semiconductor fuses located inside the power controller are classified for UL as supplementary protection for semiconductor devices. They are not approved for branch circuit protection.
-  **AVERTISSEMENT!** L'installation doit être protégée par des disjoncteurs électromagnétiques ou des fusibles. Les fusibles pour semi-conducteurs situés à l'intérieur du régulateur de puissance sont classés UL comme protection supplémentaire pour les dispositifs pour semi-conducteurs. Ils ne sont pas approuvés pour la protection des circuits de dérivation.
-  **WARNING!** When making live voltage or current measurements, use proper personal protective equipment for the voltages and arc-flash potentials involved.

-  **AVERTISSEMENT!** Au moment de relever des mesures de tension ou de courant en direct, utiliser un équipement de protection individuelle approprié pour les tensions et les potentiels d'arc électrique concernés.
-  **WARNING!** Verify the voltage and current ratings of the power controller are correct for the application.
-  **AVERTISSEMENT!** Vérifier que les valeurs de tension et de courant du régulateur de puissance sont correctes pour l'application.
-  **CAUTION:** To avoid compromising the insulation, do not bend wire or other components beyond their bend radius specifications.
-  **ATTENTION:** Pour éviter de compromettre l'isolation, ne pas plier le fil ou tout autre composant au-delà de ses spécifications en matière de rayon de courbure.
-  **CAUTION:** Protect the power controller from high temperature, humidity and vibrations.
-  **ATTENTION:** Protéger le régulateur de puissance contre les températures élevées, l'humidité et les vibrations.
-  **CAUTION:** The power controller warranty is void if the tested and approved fuses are not used.
-  **ATTENTION:** La garantie du régulateur de puissance est nulle si aucun fusible testé et approuvé n'est utilisé.
-  **CAUTION:** Only trained and authorized personnel should access and handle the internal electronics and they must follow proper electro-static prevention procedures.
-  **ATTENTION:** Seul le personnel formé et autorisé peut accéder aux composants électroniques internes et les gérer, et il doit se conformer à des procédures de prévention électrostatique appropriées.
-  **CAUTION:** Install an appropriately sized RC filter across contactor coils, relays and other inductive loads.
-  **ATTENTION:** Installer un filtre RC de dimensions appropriées sur les bobines du contacteur, les relais et autres charges par induction.
-  **CAUTION:** The thyristor units here described have been designed for use with sinusoidal networks with nominal frequency 50-60 Hz. Any application with NON-SINUSOIDAL, distorted or disturbed networks could compromise the correct operation of the unit.
-  **ATTENTION:** Les unités de thyristors décrites ici ont été conçues pour être utilisées avec des réseaux sinusoïdaux d'une fréquence nominale de 50 à 60 Hz. Toute application utilisant des réseaux NON SINUSOÏDAUX, déformés ou perturbés peut compromettre le bon fonctionnement de l'appareil.
-  **NOTE:** Provide a local disconnect to isolate the power controller for servicing.
-  **REMARQUE:** Fournir une déconnexion locale afin d'isoler le régulateur de puissance pour l'entretien.
-  **NOTE:** The nominal current is specified for ambient temperatures at or below 40° C. Ensure the application design allows for adequate cooling of each power controller. The power controller must be mounted vertically. The cooling design must prevent air heated by one power controller from causing power controllers mounted above to exceed the ambient operating temperature limit. When power controllers are mounted side by side allow a minimum spacing of 15mm between them.
-  **REMARQUE:** Le courant nominal est précisé pour des températures ambiantes égales ou inférieures à 40°C. S'assurer que la conception de l'application permette le refroidissement adéquat de chaque régulateur de puissance. Le régulateur de puissance doit être monté verticalement. La conception de refroidissement doit empêcher l'air chauffé par le régulateur de puissance de dépasser la limite de température de fonctionnement ambiante de la part des régulateurs de puissance montés au-dessus. Lorsque les régulateurs de puissance sont montés côte à côte, il faut conserver un espacement minimal de 15 mm entre les deux.
-  **NOTE:** Use only copper cables and wires rated for use at 90°C or greater.
-  **REMARQUE:** N'utiliser que des câbles et des fils en cuivre pour l'utilisation à 90°C ou plus.



## Maintenance

In order to have a corrected cooling, the user must clean the heat-sink and the protective grill of the fans. The frequency of this servicing depends on environmental pollution.

Also check periodically if the screw for the power cables and safety earth are tightened correctly (See Connection Diagram)

### Warranty condition

Producer gives a 12 months warranty to its products.

The warranty is limited to repairing and parts substitution in our factory and does exclude products not properly used and fuses.

Warranty does not include products with serial numbers deleted. The faulty product should be shipped to Producer at customer's cost and our Service will evaluate if product is under warranty terms.

Substituted parts remain of Producer property.



CD Automation srl assumes no liability for any damage to persons or property deriving from tampering, from incorrect or improper use, or from any use not conforming to the characteristics of the controller and to the instructions in this User Manual.



## Return Material Authorization (RMA)

Customers wishing to return any items, whether they are incorrectly supplied, faulty or damaged in transit, must first complete a Return Material Authorisation (RMA) form to obtain an RMA number from the Service Department.

A full repair service is available for customers. Prior to submitting the RMA form and returning products, customers are recommended to contact the technical support team to determine whether the issue can be resolved with telephone support.

### How the RMA service works

The RMA form and details are available on our web sites:

<https://www.cdautomation.com/rma-english-version/>

When completing the RMA form, please be as specific as possible about the problem, including any pertinent application details. The more information given, the more quickly and more thoroughly the problem can be solved. The minimum information required is:

1. The Full Model Number
2. Quantity of units being returned
3. The units Serial Number(s)
4. A description of the problem ("faulty" or "unknown" is not sufficient)



# Summary

- Declaration of conformity . . . . . 3
- Important warnings for safety . . . . . 4
- Maintenance . . . . . 7
- 1 Basic Connections . . . . . 9
- 2 Identification and Order Code . . . . . 10
  - 2.1 Identification of the unit . . . . . 10
  - 2.2 Order Code. . . . . 11
- 3 Technical Specifications. . . . . 12
  - 3.1 General features . . . . . 12
  - 3.2 Input features . . . . . 12
  - 3.3 Output features (power device) . . . . . 12
  - 3.4 Environmental installation conditions . . . . . 13
  - 3.5 Derating Curve . . . . . 13
- 4 Installation . . . . . 14
  - 4.1 Dimensions and Fixing holes . . . . . 14
- 5 Wiring instructions . . . . . 15
  - 5.1 Connection Diagram for Single-phase . . . . . 16
  - 5.2 Access to L1 – T1 terminal Screw. . . . . 17
  - 5.3 Connection Diagram with Flat wiring system (Option) . . . . . 18
  - 5.4 Led status and Alarms . . . . . 18
- 6 Input setting . . . . . 19
  - 6.1 Input calibration procedure (Analog Input option) . . . . . 20
- 7 Heater Break alarm and SCR short circuit (HB Option) . . . . . 21
  - 7.1 Heater break Calibration procedure. . . . . 21
  - 7.2 HB alarm contact. . . . . 21
- 8 Firing type. . . . . 22
  - 8.1 Zero Crossing (for SSR Input only) . . . . . 22
  - 8.2 Burst Firing (for Analog Input option only). . . . . 22
  - 8.3 Burst Firing settings. . . . . 23
- 9 Internal Fuse . . . . . 24
  - 9.1 Fuses Replacement . . . . . 25
- 10 Trouble shooting. . . . . 26



1

# Basic Connections

Single phase wiring with resistive load

$$I = \frac{P}{V}$$

V = Nominal voltage of the load

I = Nominal current of the load

P = Nominal power of the load

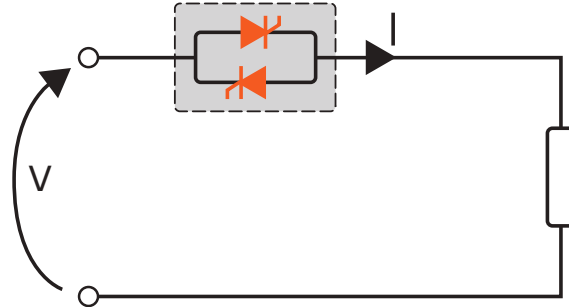

Open Delta wiring with resistive load

$$I = \frac{P_{tot}}{3V}$$

V = Nominal voltage of the load

I = Nominal current of the load

P = Nominal power of the load

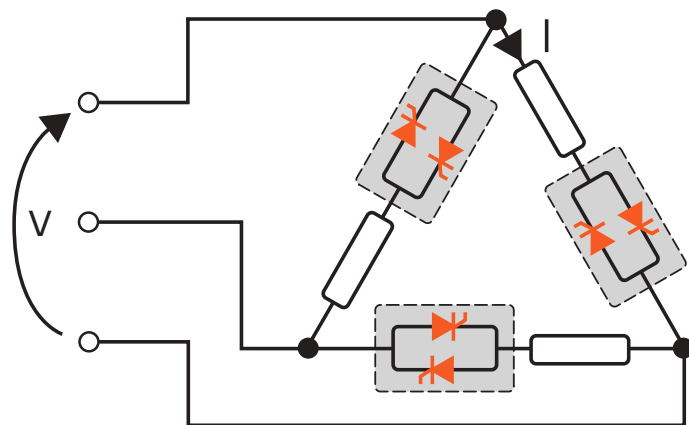

## 2 Identification and Order Code

### 2.1 Identification of the unit



**Caution:** Before to install, make sure that the Thyristor unit have not damages. If the product has a fault, please contact the dealer from which you purchased the product.

The identification label give all the information regarding the factory settings of the Thyristor unit, this label is on the unit, like represented in figure.

Verify that the product is the same thing as ordered.

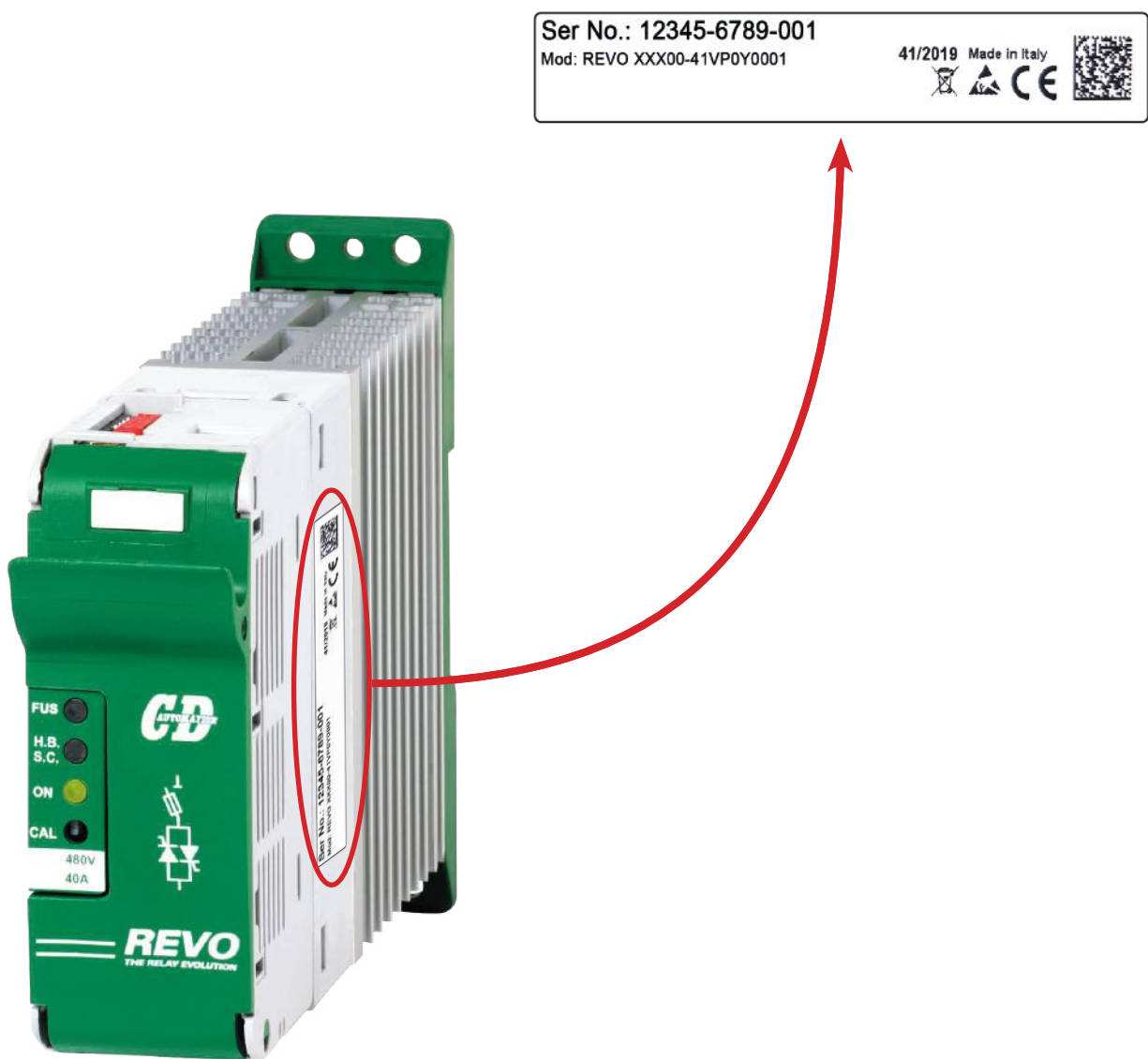

## 2.2 Order Code

	<b>1</b>	<b>2</b>	<b>3</b>	<b>4</b>	<b>5</b>	<b>6</b>	<b>7</b>	<b>8</b>	<b>9</b>	<b>10</b>	<b>11</b>	<b>12</b>	<b>13</b>	<b>14</b>	<b>15</b>	<b>16</b>
<b>REVO S 1PH</b>	R	S	1	-	-	-	-	-	-	-	-	-	-	-	-	-

<b>CURRENT</b>	4	5	6
description	code		
30A	0	3	0
35A	0	3	5
40A	0	4	0

<b>MAX VOLTAGE</b>	7
description	code
480V	4
600V	6

<b>AUX VOLTAGE SUPPLY</b>	8
description	code
No Aux Voltage without HB and/or Analog Input up to 210A included	0
With HB and/or Analog Input on all unit ≤ 210A Aux Volt 24V ac-dc	4

<b>INPUT</b>	9
description	code
SSR	S
0:10V dc	V
4:20mA	A

<b>FIRING</b>	10
description	code
Zero Crossing ZC	Z
Burst Firing 4 Cycles On at 50% Power Demand	4
Burst Firing 8 Cycles On at 50% Power Demand	8
Burst Firing 16 Cycles On at 50% Power Demand	6

<b>CONTROL MODE</b>	11
description	code
Open Loop	0

<b>FUSES &amp; OPTION</b>	12
description	code
No Fuse	0
Fuse + Fuse Holder	F
Fuse + Fuse Holder + CT	Y
Fuse + Fuse Holder + CT + HB	H
Fuse + Fuse Holder + CT + HB with Flat Cable Connection	X

<b>FAN VOLTAGE</b>	13
description	code
No Fan	0

<b>APPROVALS</b>	14
description	code
CE EMC For European Market	0
CE EMC + cUL® listed and cULus 508® listed	L

<b>MANUAL</b>	15
description	code
None	0
Italian	1
English	2
German	3
French	4

<b>VERSION</b>	16
description	code
Std unit with one fuse	1
High Sensitivity HB below 5A	5

## 3

## Technical Specifications

### 3.1 General features

Cover and Socket material:	PolymericV2
Mounting:	DIN bar (thickness type 1mm Max)
Utilization Category:	AC-51 AC-55b
IP Code:	20
Method of Connecting:	Single Phase load
Auxiliary voltage (only with HB option):	24V dc/ac (max 70mA)
Delay switch ON/OFF time:	1/2 Period Max
Relay output for Heater Break Alarm (only with HB option):	0.5A a 125VAC

### 3.2 Input features

Logic input SSR:	7 ÷ 30Vdc 9mA Max (ON $\geq$ 7Vdc OFF <6Vdc)
Logic input SSR with HB option:	4 ÷ 30Vdc 5mA Max (ON $\geq$ 4Vdc OFF <1Vdc) 3HZ Max on time min. 100 ms
Analog Input V:	0 ÷ 10Vdc (15k $\Omega$ )
Analog Input A:	0 ÷ 20mA / 4 ÷ 20mA (100 $\Omega$ )
Digital Input calib. (only with HB option):	12 ÷ 24V dc/ac (max 37mA)

### 3.3 Output features (power device)

Nominal current in continuous service:	See order code
Max peak current (10ms):	360A for unit type 030 540A for unit type 035 700A for unit type 040
Nominal Voltage range <b>Ue</b> :	24÷600V
Repetitive peak reverse voltage <b>Uimp</b> :	1200V (480V) 1600V (600V)
Latching current:	250mA
Leakage current:	15mA eff
FUSE I <sup>2</sup> T value suggested at 500Vac tp=10msec:	525 A <sup>2</sup> s for unit type 030 1260 A <sup>2</sup> s for unit type 035 1260 A <sup>2</sup> s for unit type 040
Frequency range:	47÷70Hz
Power loss (I=Inom):	38W for unit type 030 44W for unit type 035 50W for unit type 040
Isolation Voltage <b>Ui</b> :	2500Vac

### 3.4 Environmental installation conditions

Ambient temperature	0-40°C (32-104°F) at nominal current. Over 40°C use the derating curve (max 50°C).
Storage temperature	-25°C to 70°C, -13°F to 158°F
Installation place	Don't install at direct sun light, where there are conductive dust, corrosive gas, vibration or water and also in salty environmental.
Altitude	Up to 1000 meter over sea level. For higher altitude reduce the nominal current of 2% for each 100m over 1000m
Humidity	From 5 to 95% without condense and ice
Pollution Level	Up to 2nd Level ref. IEC 60947-1 6.1.3.2

### 3.5 Derating Curve

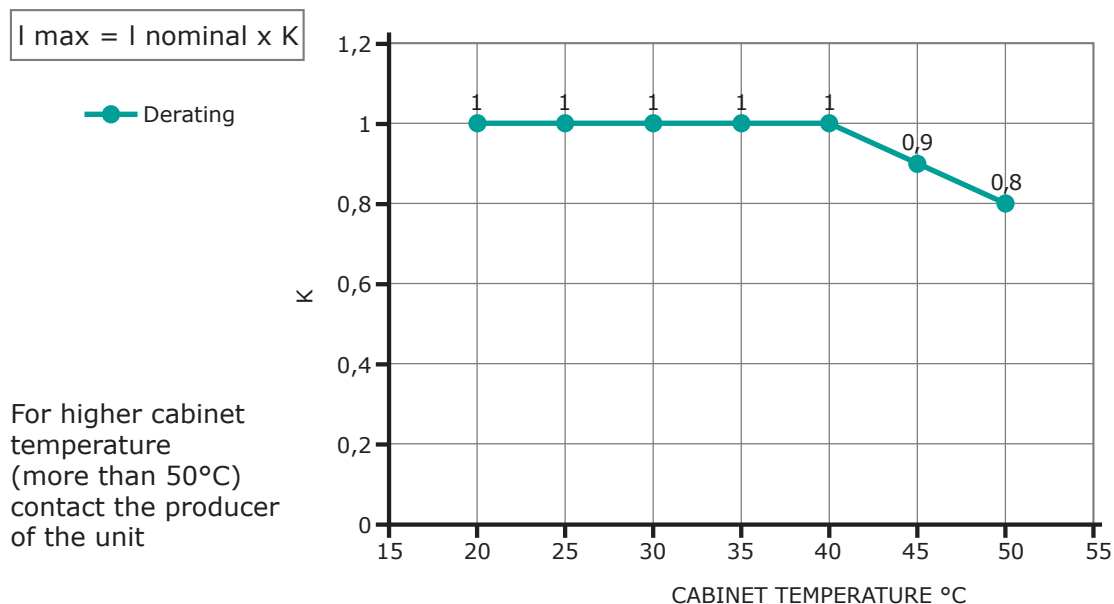

Operation at ambient operating temperature above 40°C not covered by UL®

# 4 Installation

Before to install, make sure that the Thyristor unit have not damages.

If the product has a fault, please contact the dealer from which you purchased the product. Verify that the product is the same thing as ordered.

The Thyristor unit must be always mounted in vertical position to improve air cooling on heat-sink.

Maintain the minimum distances in vertical and in horizontal as represented.

When more unit has mounted inside the cabinet maintain the air circulation like represented in figure.

Sometimes is necessary installing a fan to have better air circulation.

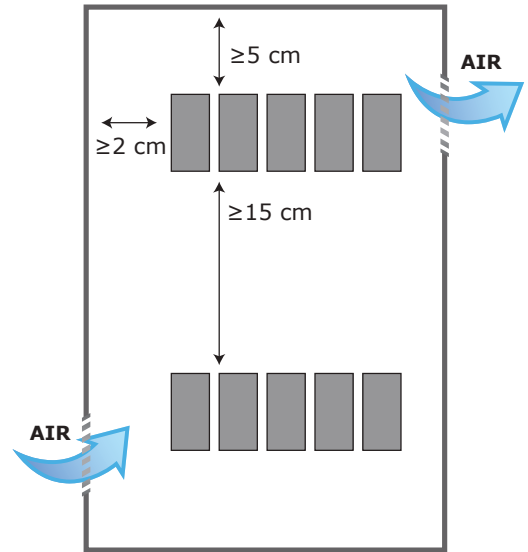

## 4.1 Dimensions and Fixing holes

Size: SR6

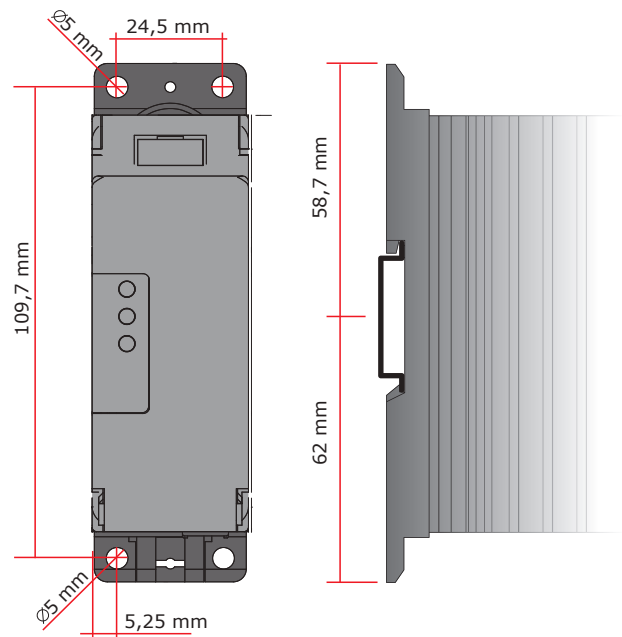
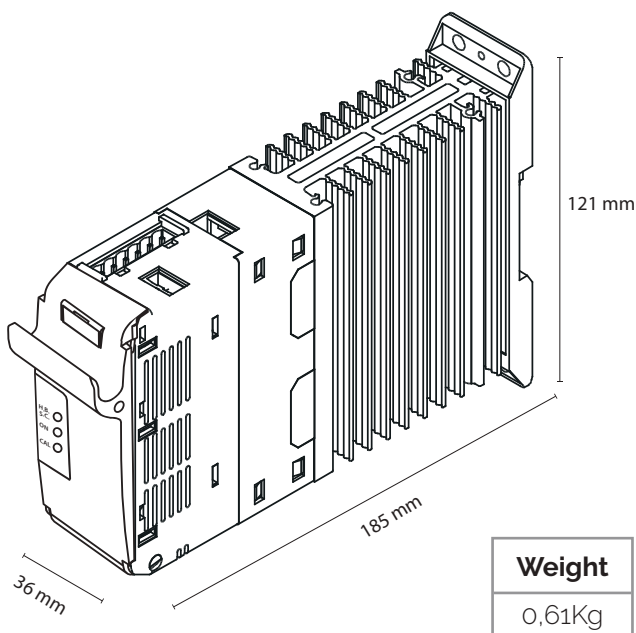

# 5 Wiring instructions

The Thyristor unit could be susceptible to interferences lost by near equipments or by the power supply, for this reason in accord to the fundamental practices rules is opportune take some precautions:

- The coil contactor, the relays and other inductive loads must be equipped with opportune RC filter.
- Use shielded bipolar cables for all the input and output signals.
- The signal cables must not be near and parallel to the power cables.
- Local regulations regarding electrical installation should be rigidly observed.

Use copper cables and wires rated for use at 90°C only.

### Power cable torque (suggested)

Type	Connector Type	Torque Lb-in (N-m)	Wire Range mm <sup>2</sup> (AWG )	MAX Current Terminals	Wire Terminals UL Listed (ZMVV)
030 035 040	Screw M5	26.6 (3.0)	1.5-10 (16-8)	45A	Rigid / Flexible Spade Terminal

### Cable dimensions of the Command Terminals

0.5 mm<sup>2</sup> (AWG 18)

### Cable dimensions of the Earth (suggested)

6 mm<sup>2</sup> (AWG 10)

### 5.1 Connection Diagram for Single-phase

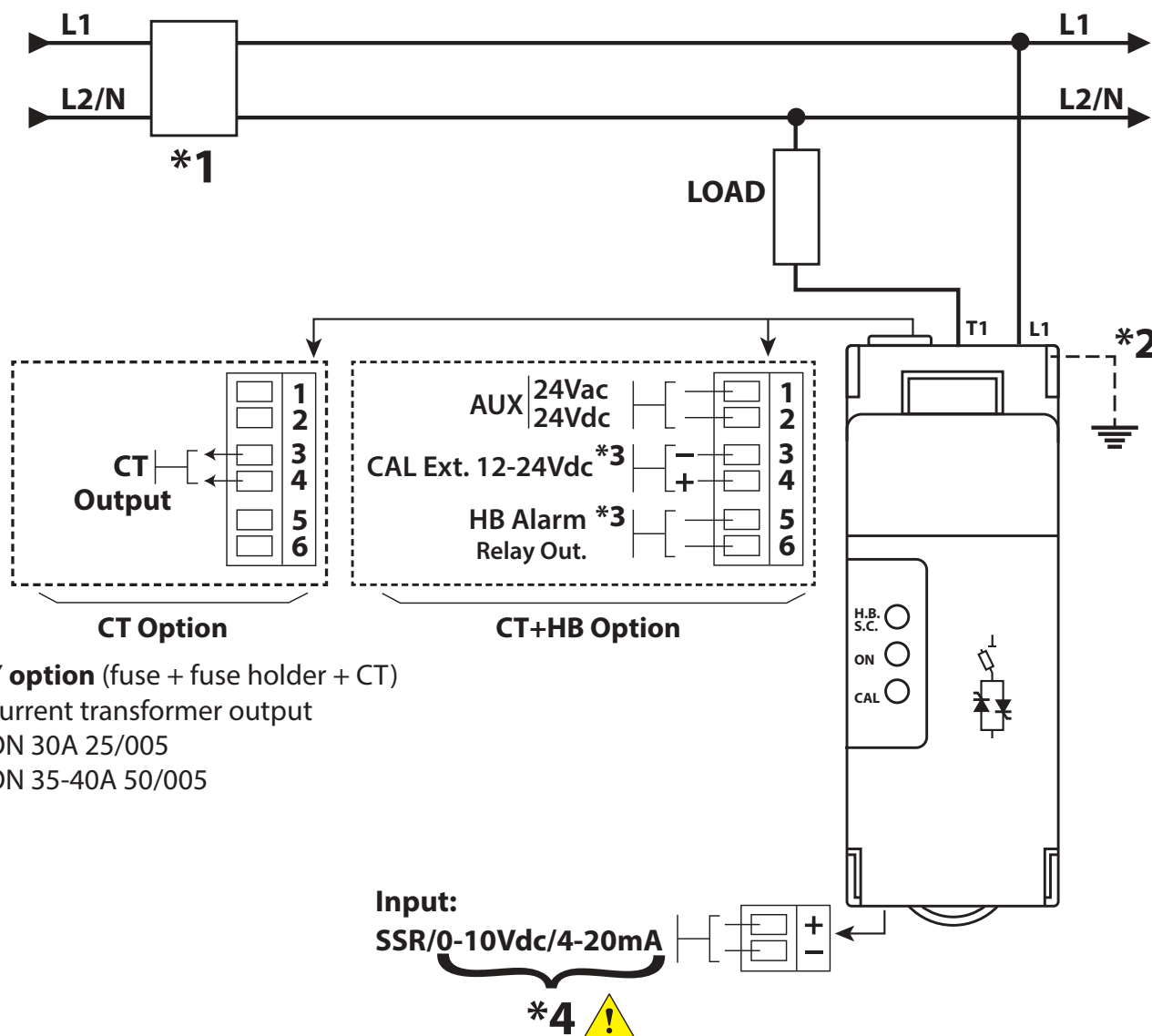

SSR Input: 4 ÷ 30Vdc 5mA Max (ON >4Vdc OFF <1Vdc)  
 Frequency 3Hz Max - On time min. 100 ms

**Note:**

- \*1 A suitable device must ensure that the unit can be electrically isolated from the supply (electromagnetic circuit breaker or by fuse isolator), this allows the qualified people to work in safety.
- \*2 The heat-sink must be connected to the earth.
- \*3 *Only for the HB option* See par. "Heater break Alarm and SCR short circuit"

**\*4** ⚠️ **Analog Input Connection**

- The analog input is not isolated from Aux Supply. A series connection between analog inputs of the units is not possible
- With AC Aux supply it's not possible** connect the zero terminal (-) of Analog Input to the earth.
- With DC Aux supply it's not possible** to connect the zero of the power supply (terminal 1 and 2) with the zero (-) of analog input
- Never connect** terminals "1" and "2" to earth



### 5.2 Access to L1 – T1 terminal Screw

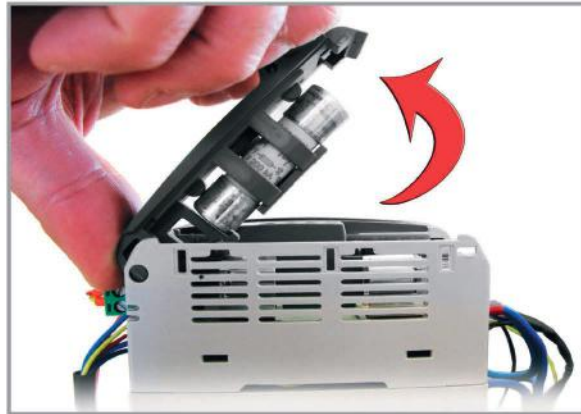
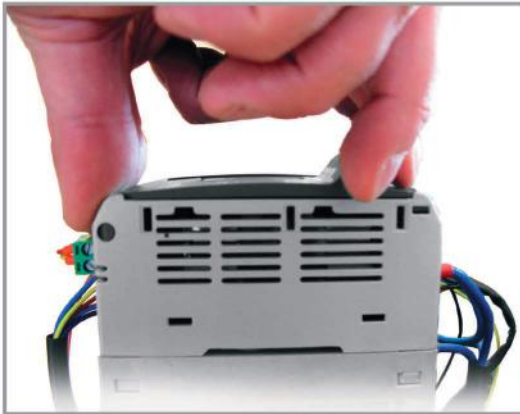

1. Open fuse holder by pulling the frontal cover

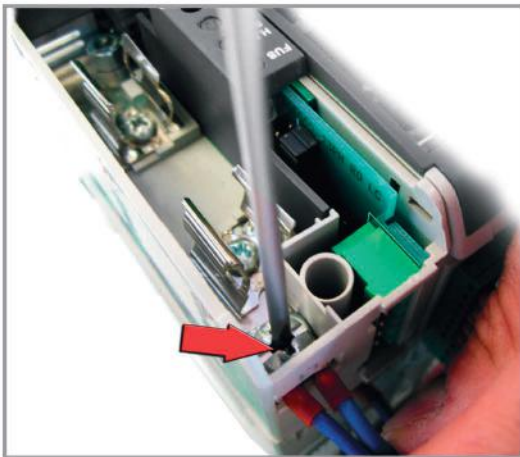

2. Fix the wire on Ln

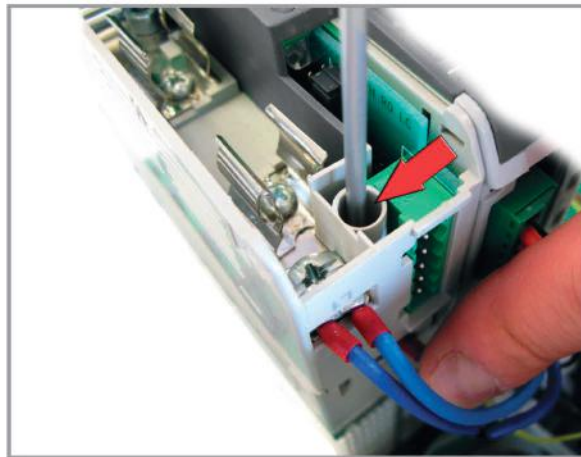

3. Fix the wire on Tn

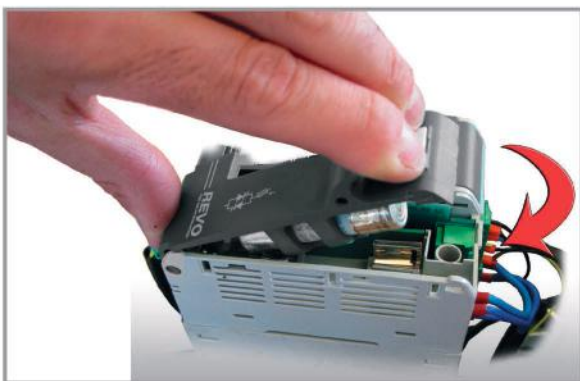

4. Close the cover by pressing

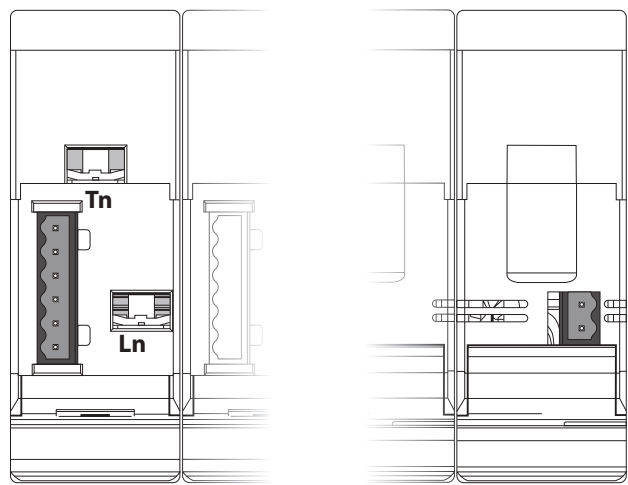

TOP VIEW

DOWN VIEW

### 5.3 Connection Diagram with Flat wiring system (Option)

(Max 16 module connection)

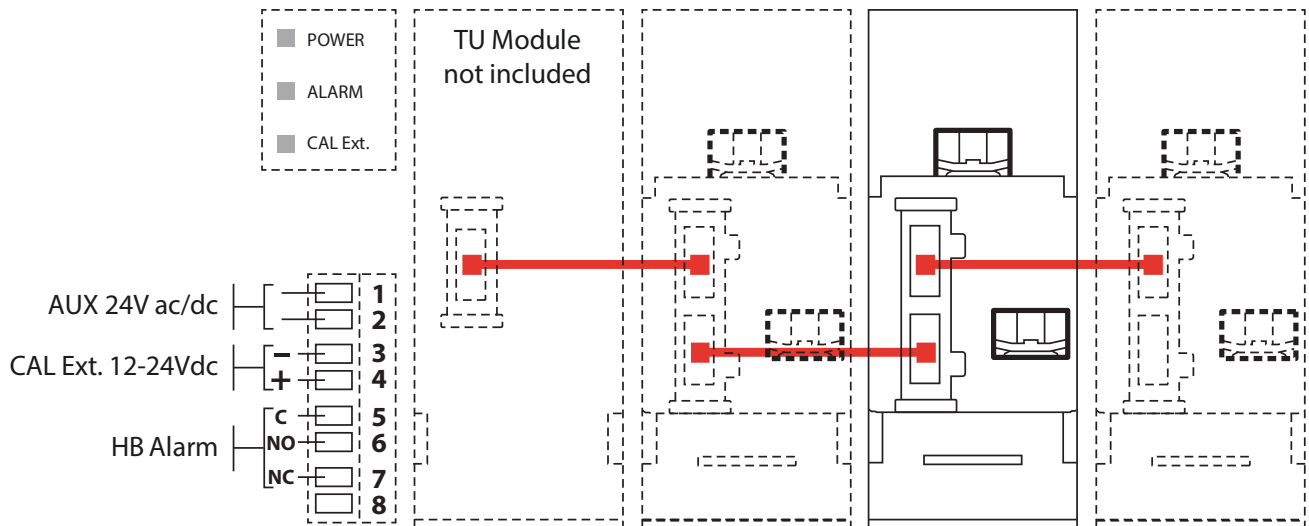

### 5.4 Led status and Alarms

LED	STATUS	DESCRIPTION
H.B. S.C.	LED OFF ( ● )	Load OK
	LED ON (Yellow ● )	Load Fault (only with HB option)
	LED ON (Red ● )	SCR short circuit (only with HB option)
ON	LED OFF ( ● )	Load is NOT powered
	LED ON (Green ● )	Load is powered

## 6 Input setting

The input type is already configured in line with customer requirements that are defined in the Order Code. However, if you wish to change the input type (ex. from 0÷10V to 4÷20mA) set the jumpers as below represented and then do the "Input calibration procedure".

**Important:** The analog input isn't isolated from Aux Supply. The series connection between analog inputs of the units is not possible. With AC Aux supply it's not possible connect the zero terminal of Analog Input to the earth. With DC Aux supply is not possible to connect the zero of the power supply with the zero of analog input.



**Warning:** Before operate, be sure that power and control cables are isolated from voltage sources.

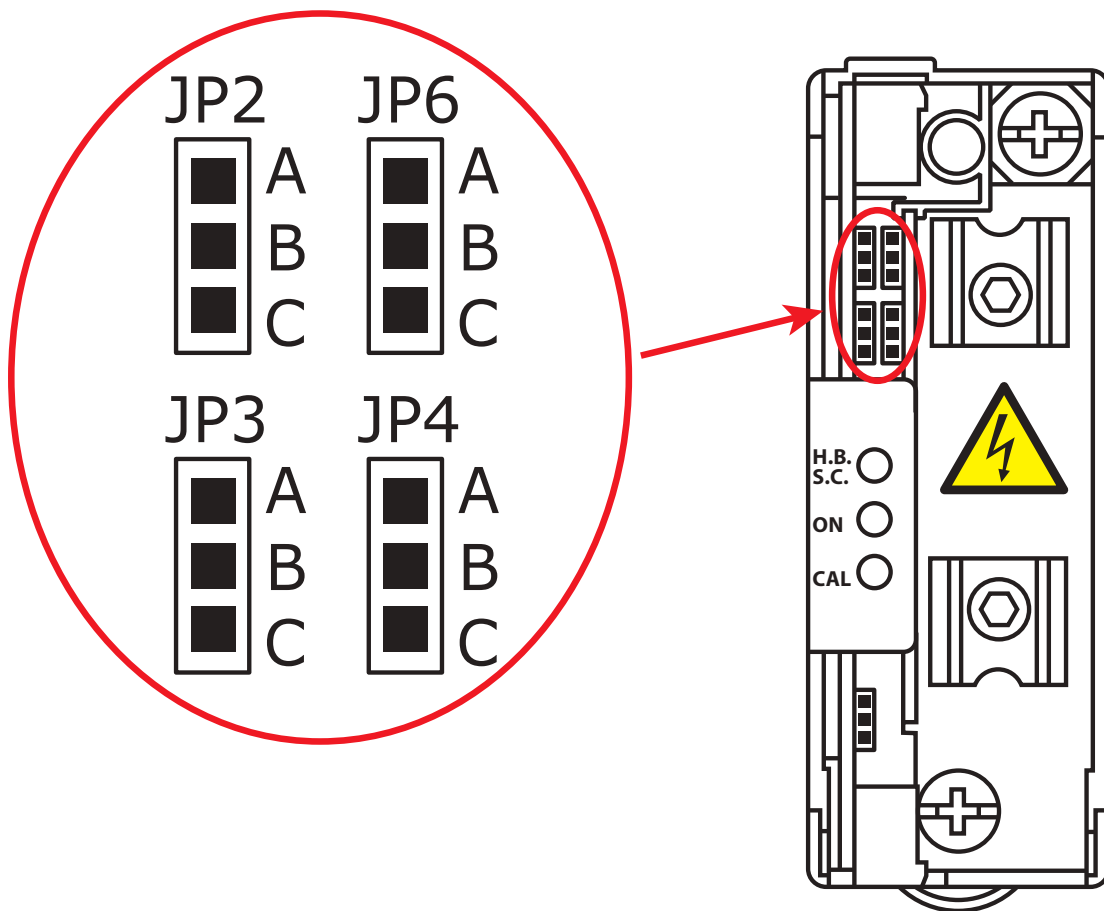

Input	JP2	JP3	JP6
SSR	A-B	B-C	A-B
4÷20mA Analog Input option	B-C	A-B	B-C
0÷10Vdc Analog Input option	B-C	B-C	B-C

### 6.1 Input calibration procedure (Analog Input option)



**Warning:** this procedure can be done just by specialized personnel and is needed only if you change the input type.

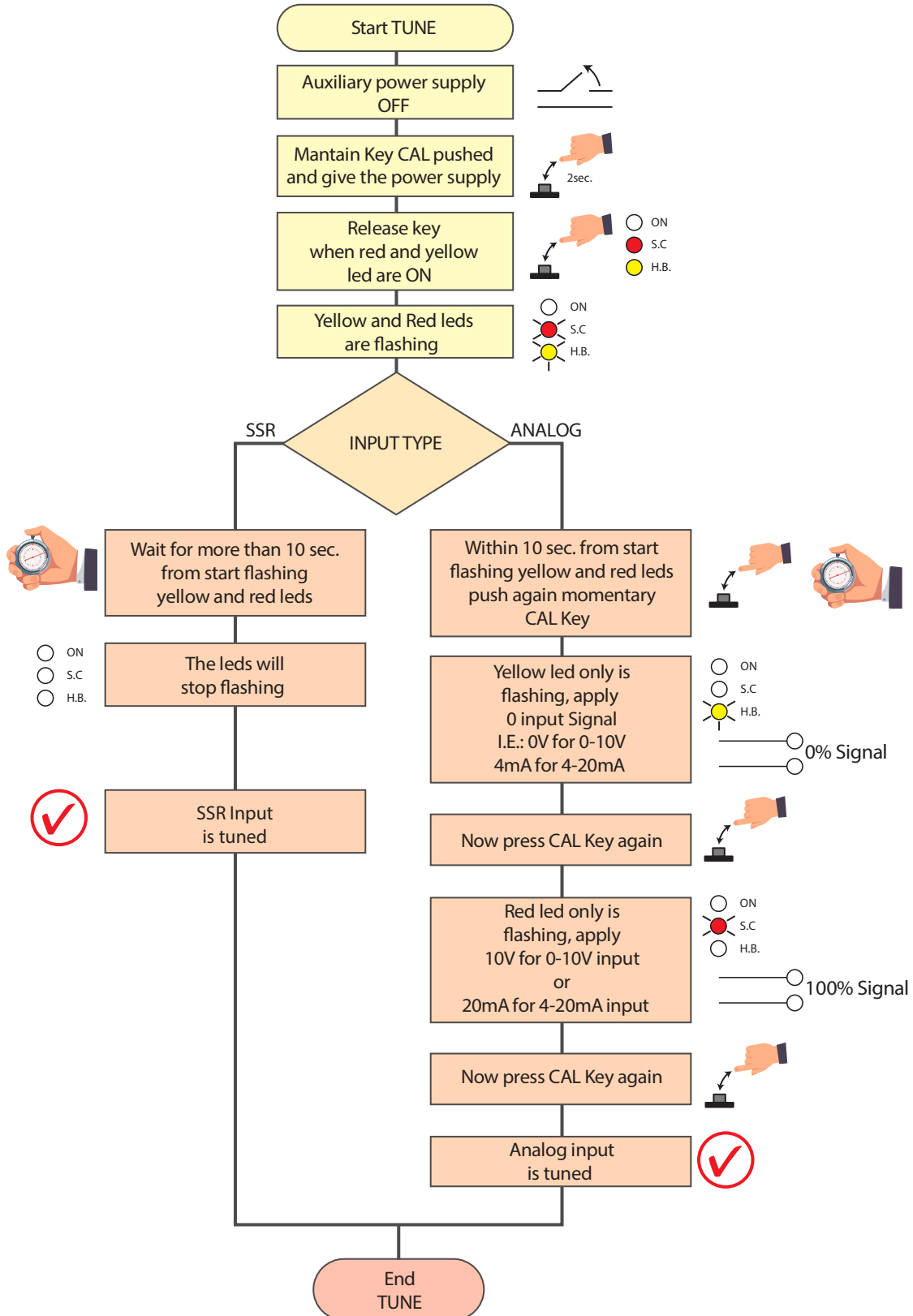

# 7 Heater Break alarm and SCR short circuit (HB Option)



**Caution:** to work properly the load must be powered at least about 160msec.

The Heater Break circuit read the load current with an Internal current transformer (C.T.). Minimum current is 10% of the current transformer size. If load current is below this value the Heater Break Alarm doesn't work properly.

## 7.1 Heater break Calibration procedure

An automatic function sets the Heater Break Alarm. The auto setting function can be activated using the "CAL" button on front unit, or supply with 12-24Vdc the digital input "Cal Ext." (See Connection Diagram). The Heater Break calibration procedure is performed in this way:

- The Unit gives the maximum voltage output
- all LEDs are on, this means that calibration procedure is active
- The current value is stored in memory
- After about 15 second the unit comes back to the initial situation

If load current decreases for partial or total load failure (sensitivity 20%) the yellow LED HB become ON and alarm relay change status.

If the unit is still in conduction with no input signal (LED green OFF) it means that there is a short circuit on thyristors and red LED (SC) become ON.

If the load has been changed the Heater Break calibration procedure must be done again

## 7.2 HB alarm contact

The Revo unit with HB option, is supplied with Heater Break alarm contact normally opened (NO):

- In normal conditions (without alarm) and with auxiliary power supply, the contact to the terminals has opened (relay coil energized).
- In alarm condition or without auxiliary power supply the contact to the terminals is closed (relay coil not energized).

if you wish to change the alarm contact open the Fuse-holder module and set the jumper as shown.



**Warning:** Before operate, be sure that power and control cables are isolated from voltage sources.

Type	JP1
NO (standard)	A-B
NC	B-C

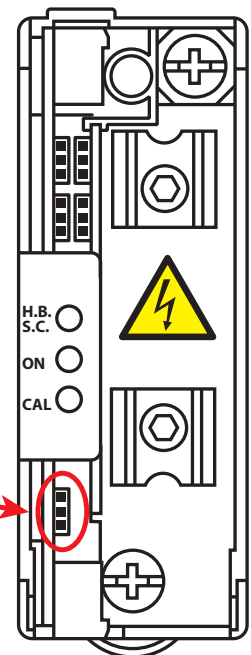
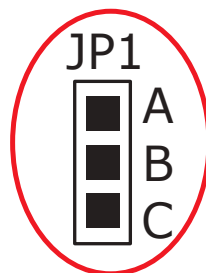

# 8 Firing type

## 8.1 Zero Crossing (for SSR Input only)

ZC firing mode is used with Logic Output from temperature controllers and the Thyristor operates like a contactor.

The Cycle time is performed by temperature controller. ZC minimizes interferences because the Thyristor unit switches ON-OFF at zero voltage.

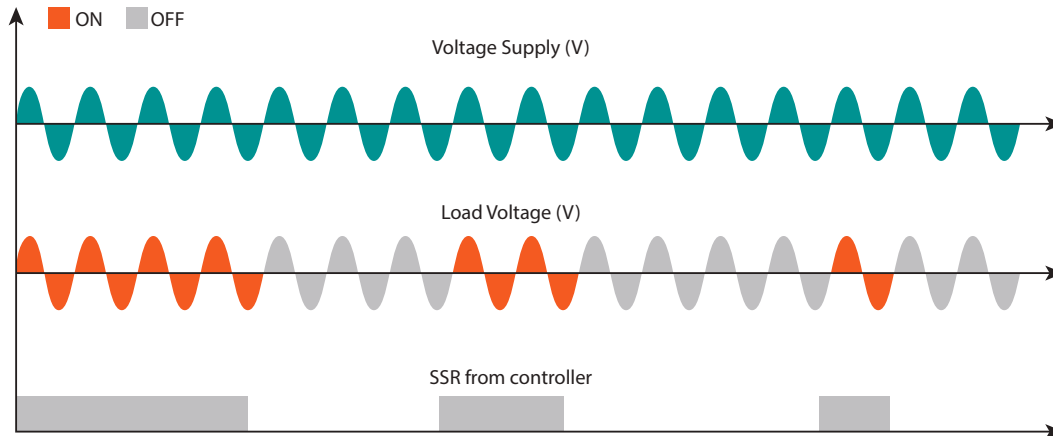

## 8.2 Burst Firing (for Analog Input option only)

The Burst Firing is a burst of consecutive cycles, the consecutive cycles ON are selectable (4,8,16), with input signal equal at 50%.

Burst Firing is a method zero crossing that it reduces the electromagnetic interferences because the thyristor switches at zero voltage crossing.

The example show the Burst Firing with Burst cycles = 4

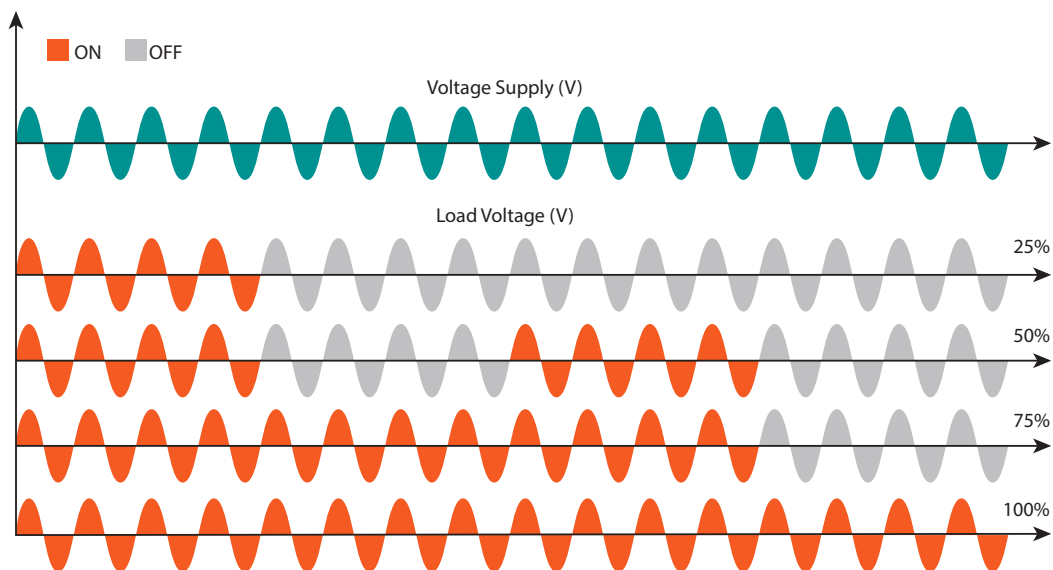

### 8.3 Burst Firing settings

The Burst Firing cycles is already configured in line with customer requirements that are defined in the Order Code. However, if you wish to change the Burst Firing cycles (es. from 4 to 8) set the jumpers as below represented:



**Warning:** Before operate, be sure that power and control cables are isolated from voltage sources.

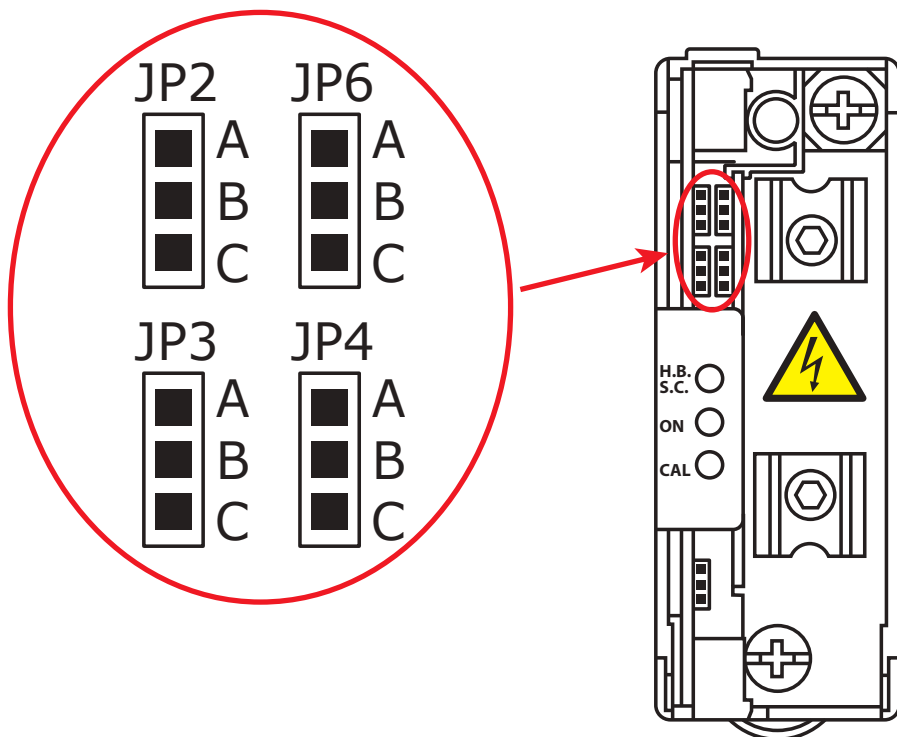

Burst Cycles	JP4
BF4	Open
BF8	A-B
BF16	B-C

# 9 Internal Fuse

The thyristor unit have internal fuse extrarapid at low I<sup>2</sup>T for the thyristor protection of against the short-circuits. The Fuses must have I<sup>2</sup>T 20% less than thyristor's I<sup>2</sup>T. The warranty of thyristor is null if no proper fuses are used.

Type	Fuse Code Spare Part	Total Current (A <sub>RMS</sub> )	I <sup>2</sup> T at 500Vac* (A <sup>2</sup> sec.)	Vac	Quantity for each phase
030	FU1451/40A	40	525	660	1
035	FU1451/50A	50	1260	660	1
040	FU1451/50A	50	1260	660	1

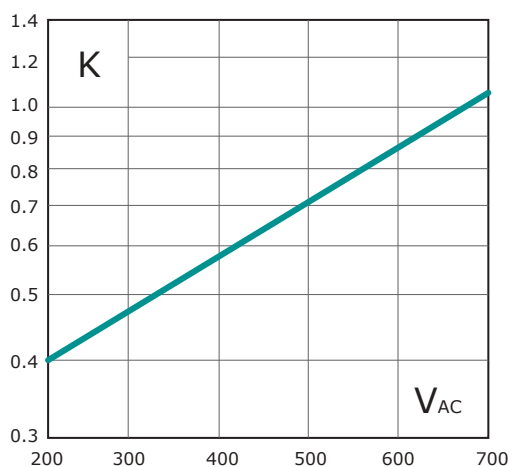

\*I<sup>2</sup>T are multiplied for K value in function of Vac at 500V K is equal to 0,7 (750 X 0,7 = 525 1800 X 0,7 =1250). At 660Vac K is equal to 1.



**Caution:** High speed fuses are used only for the thyristor protection and can not be used to protect the installation.



**Caution:** The warranty of thyristor is null if no proper fuses are used. See tab.



**Warning:** When it is supply, the Thyristor unit is subject to dangerous voltage, don't open the Fuse-holder module and don't touch the electric equipments.



## 9.1 Fuses Replacement

Open the Fuse-Holder

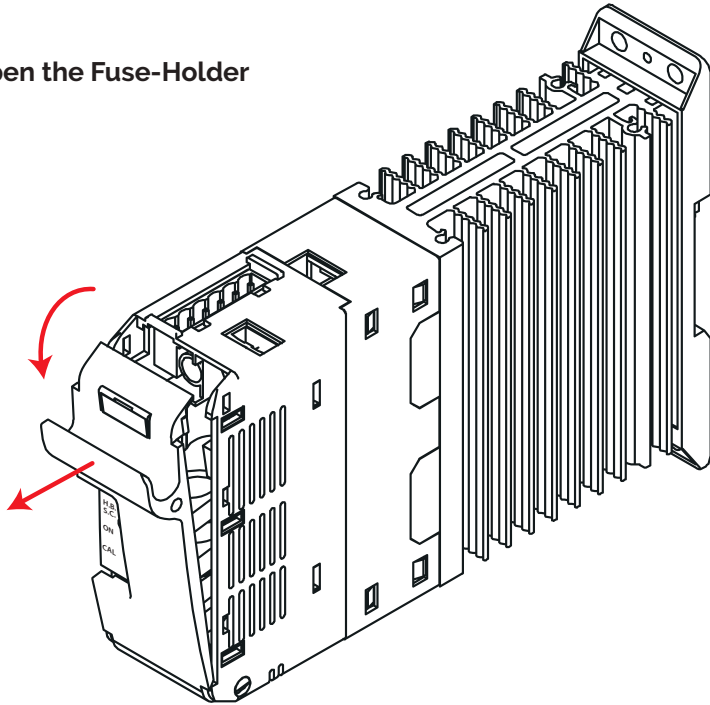

Pull out the fuse

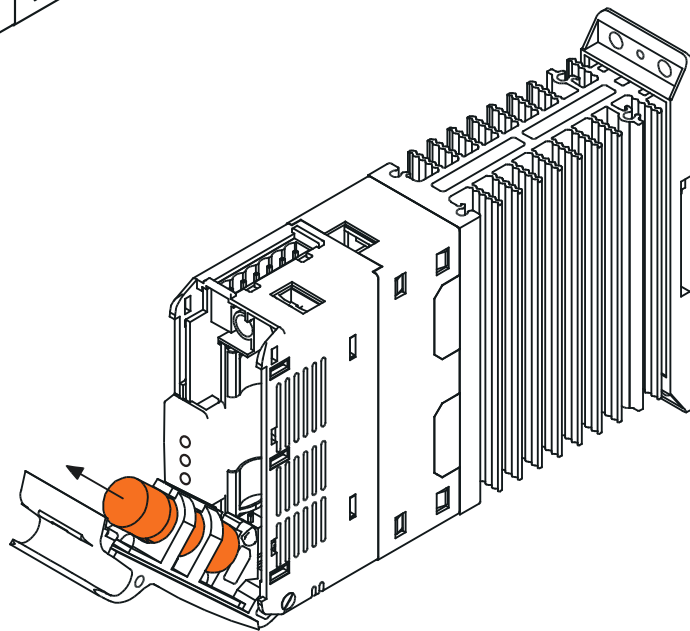

# 10 Trouble shooting

Small problems sometimes can be solved locally with the help of the below tab of trouble shooting. If you don't succeed, contact us or your nearest distributor.

Symptom	Indication on front unit	Possible reasons of the symptom	Actions
Load current doesn't flow	Green LED (ON) light OFF (●)	<ul style="list-style-type: none"> <li>No Auxiliary Voltage</li> <li>No input signal</li> <li>Reversed polarities of input signal</li> </ul>	<ul style="list-style-type: none"> <li>Give auxiliary voltage supply (See Connection Diagram)</li> <li>Provide to give input signal</li> <li>Reverse the input signal polarity</li> </ul>
	Green LED (ON) light ON (●)	<ul style="list-style-type: none"> <li>Fuse failure</li> <li>Load connection interruption</li> <li>Load failure: The yellow led (HB) is light on (with HB option)</li> <li>Thyristor fault: The red led (SC) is light on (with HB option)</li> </ul>	<ul style="list-style-type: none"> <li>Change the fuse</li> <li>Check the wiring</li> <li>Check the load</li> <li>Change the thyristor module</li> </ul>
Load current flow also without input signal	Red LED (SC) light ON (●)	<ul style="list-style-type: none"> <li>Wrong wiring</li> <li>SCR short circuit</li> </ul>	<ul style="list-style-type: none"> <li>Check the wiring</li> <li>Change the thyristor module</li> </ul>
Current flows at nominal value but Yellow LED (HB/SC) is light on	Yellow LED (HB) light ON (●) or Red LED (SC) light ON (●)	<ul style="list-style-type: none"> <li>HB circuit not tuned</li> <li>Current transformers not properly wired</li> </ul>	<ul style="list-style-type: none"> <li>Make HB calibration procedure</li> <li>Check current transformers wiring</li> </ul>
Thyristor unit doesn't work properly		<ul style="list-style-type: none"> <li>Auxiliary voltage supply out of limits</li> <li>Wrong input signal selection</li> <li>Wrong input signal calibration (out of range)</li> </ul>	<ul style="list-style-type: none"> <li>Verify the auxiliary voltage supply</li> <li>Control input signal setting</li> <li>Check input setting</li> </ul>



**CD Automation S.r.l.**

Via Picasso, 34/36 - 20025 Legnano (MI) - Italy

Tel. +39 0331 577479 - Fax +39 0331 579479

E-mail: [info@cdautomation.com](mailto:info@cdautomation.com) - Web: [www.cdautomation.com](http://www.cdautomation.com)