

USER'S MANUAL

Rev. 11/2022

REVEX 1PH

from 60A to 90A

016

M-RX1-60-90



CD Automation S.r.l.

Via Picasso, 34/36 - 20025 Legnano (MI)- Italy

Tel. +39 0331 577479 - Fax +39 0331 579479

E-mail: info@cdautomation.com - Web: www.cdautomation.com



Declaration of conformity

Declaration of conformity-Dichiarazione di Conformità

PRODUCT MANUFACTURER/ PRODUTTORE:



CD Automation S.R.L.
Controllers, Drives & Automation

Via Picasso, 34/36 - 20025 Legnano (MI)- Italy
P.I. 08925720156 -Tel. +39 0331 577479 - Fax +39 0331 579479
E-mail: info@cdautomation.com - Web: www.cdautomation.com

Declare that the product / Dichiaro che il prodotto:

REVEX 1Ph 60-90A

PRODUCT DESCRIPTION: Electric power control
SCOPE OF APPLICATION: Thermal control process
DESCRIZIONE DEL PRODOTTO: Unità di controllo potenza elettrica
UTILIZZO: Controllo processi termici

FULFILLS THE REQUIREMENTS OF THE STANDARD:

Electrical safety Standard EN60947-1: 2007 + A1 2011, A2 2014
EN60947-4-3: 2014
Generic Emission standard EN60947-4-3: 2014 Group 1 Class A emissions
Generic Immunity standard EN60947-4-3: 2014 Industrial Immunity

SODDISFA I REQUISITI DELLA NORMA:

Specifica di sicurezza EN60947-1: 2007 + A1 2011, A2 2014
EN60947-4-3: 2014
Specifica sulle emissioni EN60947-4-3: 2014 gruppo 1 emissioni classe A
Specifica sulle Immunità EN60947-4-3: 2014 Immunità industriale

CDAutomation declares that the products above mentioned are conforming to the directive
CDAutomation dichiara che i prodotti sopra menzionati sono conformi alla direttiva
Alla direttiva Bassa Tensione (low Voltage) **EMC directive updated 2014/30/EU,**
Low Voltage Directive updated 2014/35/EU

Issued on: 20/03/2017
Data di emissione: 20/03/2017

Amministratore Unico e
Legale Rappresentante
Simone Brizzi



Declaration of conformity

Declaration of conformity-Dichiarazione di Conformità



PRODUCT MANUFACTURER/ PRODUTTORE:



CD Automation S.R.L.
Controllers, Drives & Automation

Via Picasso, 34/36 - 20025 Legnano (MI)- Italy
P.I. 08925720156 -Tel. +39 0331 577479 - Fax +39 0331 579479
E-mail: info@cdautomation.com - Web: www.cdautomation.com

Declare that the product / Dichiaro che il prodotto:

REVEX 1Ph 60-90A

PRODUCT DESCRIPTION: Electric power control
SCOPE OF APPLICATION: Thermal control process
DESCRIZIONE DEL PRODOTTO: Unità di controllo potenza elettrica
UTILIZZO: Controllo processi termici

FULFILLS THE REQUIREMENTS OF THE STANDARD:

Electrical safety Standard	EN60947-1: 2007 + A1 2011, A2 2014 EN60947-4-3: 2014
Generic Emission standard	EN60947-4-3: 2014 Group 1 Class A emissions
Generic Immunity standard	EN60947-4-3: 2014 Industrial Immunity

SODDISFA I REQUISITI DELLA NORMA:

Specifica di sicurezza	EN60947-1: 2007 + A1 2011, A2 2014 EN60947-4-3: 2014
Specifica sulle emissioni	EN60947-4-3: 2014 gruppo 1 emissioni classe A
Specifica sulle Immunità	EN60947-4-3: 2014 Immunità industriale

CDAutomation declares that the products above mentioned are conforming to the directive
CDAutomation dichiara che i prodotti sopra menzionati sono conformi alla direttiva
Alla direttiva Bassa Tensione (low Voltage) **EMC directive updated 2014/30/EU,**
Low Voltage Directive updated 2014/35/EU

Issued on: 07/03/2022
Data di emissione: 07/03/2022







Amministratore Unico e
Legale Rappresentante
Simone Brizzi

Important warnings for safety

This chapter contains important information for the safety. The not observance of these instructions may result in serious personal injury or death and can cause serious damages to the Thyristor unit and to the components system included.

The installation should be performed by qualified persons.

In the manual are used symbols to give more evidence at the notes of safety and operativity for the attention for the user:

	This icon is present in all the operational procedures where the Improper operation may result in serious personal injury or death by Electrical Shock Hazard Symbol (a lightning bolt in a triangle) precedes an electric shock hazard CAUTION or WARNING safety statement.
	Warning or Hazard that needs further explanation than the label on unit can provide. Consult User's Guide for further information.
	Unit is compliant with European Union directives. See Declaration of Conformity for further details on Directives and Standards used for Compliance.
	If available, unit is a Listed device per Underwriters Laboratories. It has been investigated to ANSI/UL® 508 standards for Industrial Control Switches and equivalent to CSA C22.2 #14. For more detail search for File E231578 on www.ul.com
	ESD Sensitive product, use proper grounding and handling techniques when installing or servicing product.
	Do not throw in trash, use proper recycling techniques or consult manufacturer for proper disposal.

A **"NOTE"** marks a short message to alert you to an important detail.

A **"CAUTION"** safety alert appears with information that is important for protecting your equipment and performance. Be especially careful to read and follow all cautions that apply to your application.





















A **"WARNING"** safety alert appears with information that is important for protecting you, others and equipment from damage. Pay very close attention to all warnings that apply to your application.

Safety notes

 **WARNING!** To avoid damage to property and equipment, injury and loss of life, adhere to applicable electrical codes and standard wiring practices when installing and operating this product. Failure to do so could result in damage, injury and death.

 **AVERTISSEMENT!** Pour éviter d'endommager la propriété et l'équipement, les blessures et la perte de vie, respecter les codes électriques en vigueur et les pratiques de câblage standard au moment de l'installation et de l'utilisation de ce produit. Dans le cas contraire, cela peut entraîner la mort, des blessures graves ou des dommages.

-  **WARNING!** All service including inspection, installation, wiring, maintenance, troubleshooting, fuse or other user serviceable component replacement must be performed only by properly qualified personnel. Service personnel must read this manual before proceeding with work. While service is being performed unqualified personnel should not work on the unit or be allowed in the immediate vicinity.
-  **AVERTISSEMENT!** Tous les services, y compris l'inspection, l'installation, le câblage, l'entretien, le dépannage, le remplacement de fusibles ou d'autres composants pouvant être réparés par l'utilisateur, doivent être effectués uniquement par un personnel d'entretien qualifié. Le personnel de service doit lire ce manuel avant d'effectuer tout travail. Pendant que l'entretien est exécuté, tout personnel non qualifié ne doit effectuer de travail sur l'appareil ni se trouver à proximité.
-  **WARNING!** When in use the power controller is connected to dangerous voltages. Do not remove the protective covers without first disconnecting and preventing power from being restored while servicing the unit.
-  **AVERTISSEMENT!** Au moment de l'utilisation, le régulateur de puissance est connecté à des tensions dangereuses. Ne retirer aucun couvercle de protection sans d'abord débrancher l'appareil et ainsi empêcher l'alimentation d'être rétablie pendant l'entretien.
-  **WARNING!** Do not use in aerospace or nuclear applications.
-  **AVERTISSEMENT!** Ne pas utiliser pour les applications aérospatiales ou nucléaires.
-  **WARNING!** The units are not developed to manage capacitive loads.
-  **AVERTISSEMENT!** Les unités ne sont pas développées pour la conduite de charges capacitatives.
-  **WARNING!** The power controller's protection rating is IP20 with all covers installed and closed. It must be installed in an enclosure that provides all the necessary additional protections appropriate for the environment and application.
-  **AVERTISSEMENT!** L'indice de protection du régulateur de puissance est de IP20 lorsque les couvercles sont installés et fermés. L'appareil doit être installé dans une enceinte qui assure toute la protection supplémentaire nécessaire pour l'environnement et l'application.
-  **WARNING!** Ground the power controller via the provided protective earth grounding terminal. Verify ground is within impedance specifications. This should be verified periodically.
-  **AVERTISSEMENT!** Mise à la terre du régulateur de puissance par le biais de la borne de prise de terre de protection fournie. Vérifier que la prise de terre est conforme aux spécifications de l'impédance. Cela doit être vérifié périodiquement.
-  **WARNING!** Electric Shock Hazard: when the power controller has been energized, after shutting off the power, wait at least one minute for internal capacitors to discharge before commencing work that brings you in to contact with power connections or internal components.
-  **AVERTISSEMENT!** Risque de décharges électriques: lorsque le régulateur de puissance est mis sous tension, après avoir été éteint, attendre au moins une minute pour que les condensateurs internes se déchargent avant de commencer tout travail incluant le contact avec les connexions électriques ou les composants internes.
-  **WARNING!** The installation must be protected by electromagnetic circuit breakers or by fuses. The semiconductor fuses located inside the power controller are classified for UL as supplementary protection for semiconductor devices. They are not approved for branch circuit protection.
-  **AVERTISSEMENT!** L'installation doit être protégée par des disjoncteurs électromagnétiques ou des fusibles. Les fusibles pour semi-conducteurs situés à l'intérieur du régulateur de puissance sont classés UL comme protection supplémentaire pour les dispositifs pour semi-conducteurs. Ils ne sont pas approuvés pour la protection des circuits de dérivation.
-  **WARNING!** When making live voltage or current measurements, use proper personal protective equipment for the voltages and arc-flash potentials involved.

-  **AVERTISSEMENT!** Au moment de relever des mesures de tension ou de courant en direct, utiliser un équipement de protection individuelle approprié pour les tensions et les potentiels d'arc électrique concernés.
-  **WARNING!** Verify the voltage and current ratings of the power controller are correct for the application.
-  **AVERTISSEMENT!** Vérifier que les valeurs de tension et de courant du régulateur de puissance sont correctes pour l'application.
-  **CAUTION:** To avoid compromising the insulation, do not bend wire or other components beyond their bend radius specifications.
-  **ATTENTION:** Pour éviter de compromettre l'isolation, ne pas plier le fil ou tout autre composant au-delà de ses spécifications en matière de rayon de courbure.
-  **CAUTION:** Protect the power controller from high temperature, humidity and vibrations.
-  **ATTENTION:** Protéger le régulateur de puissance contre les températures élevées, l'humidité et les vibrations.
-  **CAUTION:** The power controller warranty is void if the tested and approved fuses are not used.
-  **ATTENTION:** La garantie du régulateur de puissance est nulle si aucun fusible testé et approuvé n'est utilisé.
-  **CAUTION:** Only trained and authorized personnel should access and handle the internal electronics and they must follow proper electro-static prevention procedures.
-  **ATTENTION:** Seul le personnel formé et autorisé peut accéder aux composants électroniques internes et les gérer, et il doit se conformer à des procédures de prévention électrostatique appropriées.
-  **CAUTION:** Install an appropriately sized RC filter across contactor coils, relays and other inductive loads.
-  **ATTENTION:** Installer un filtre RC de dimensions appropriées sur les bobines du contacteur, les relais et autres charges par induction.
-  **CAUTION:** The thyristor units here described have been designed for use with sinusoidal networks with nominal frequency 50-60 Hz. Any application with NON-SINUSOIDAL, distorted or disturbed networks could compromise the correct operation of the unit.
-  **ATTENTION:** Les unités de thyristors décrites ici ont été conçues pour être utilisées avec des réseaux sinusoïdaux d'une fréquence nominale de 50 à 60 Hz. Toute application utilisant des réseaux NON SINUSOÏDAUX, déformés ou perturbés peut compromettre le bon fonctionnement de l'appareil.
-  **NOTE:** Provide a local disconnect to isolate the power controller for servicing.
-  **REMARQUE:** Fournir une déconnexion locale afin d'isoler le régulateur de puissance pour l'entretien.
-  **NOTE:** The nominal current is specified for ambient temperatures at or below 40° C. Ensure the application design allows for adequate cooling of each power controller. The power controller must be mounted vertically. The cooling design must prevent air heated by one power controller from causing power controllers mounted above to exceed the ambient operating temperature limit. When power controllers are mounted side by side allow a minimum spacing of 15mm between them.
-  **REMARQUE:** Le courant nominal est précisé pour des températures ambiantes égales ou inférieures à 40°C. S'assurer que la conception de l'application permette le refroidissement adéquat de chaque régulateur de puissance. Le régulateur de puissance doit être monté verticalement. La conception de refroidissement doit empêcher l'air chauffé par le régulateur de puissance de dépasser la limite de température de fonctionnement ambiante de la part des régulateurs de puissance montés au-dessus. Lorsque les régulateurs de puissance sont montés côte à côte, il faut conserver un espacement minimal de 15 mm entre les deux.
-  **NOTE:** Use only copper cables and wires rated for use at 90°C or greater.
-  **REMARQUE:** N'utiliser que des câbles et des fils en cuivre pour l'utilisation à 90°C ou plus.



Maintenance

In order to have a corrected cooling, the user must clean the heat-sink and the protective grill of the fans. The frequency of this servicing depends on environmental pollution.

Also check periodically if the screw for the power cables and safety earth are tightened correctly (See Connection Diagram).

Warranty condition

Producer gives a 12 months warranty to its products.

The warranty is limited to repairing and parts substitution in our factory and does exclude products not properly used and fuses.

Warranty does not include products with serial numbers deleted. The faulty product should be shipped to Producer at customer's cost and our Service will evaluate if product is under warranty terms.

Substituted parts remain of Producer property.



CD Automation srl assumes no liability for any damage to persons or property deriving from tampering, from incorrect or improper use, or from any use not conforming to the characteristics of the controller and to the instructions in this User Manual.



Return Material Authorization (RMA)

Customers wishing to return any items, whether they are incorrectly supplied, faulty or damaged in transit, must first complete a Return Material Authorisation (RMA) form to obtain an RMA number from the Service Department.

A full repair service is available for customers. Prior to submitting the RMA form and returning products, customers are recommended to contact the technical support team to determine whether the issue can be resolved with telephone support.

How the RMA service works

The RMA form and details are available on our web sites:

<https://www.cdautomation.com/rma-english-version/>

When completing the RMA form, please be as specific as possible about the problem, including any pertinent application details. The more information given, the more quickly and more thoroughly the problem can be solved. The minimum information required is:

1. The Full Model Number
2. Quantity of units being returned
3. The units Serial Number(s)
4. A description of the problem ("faulty" or "unknown" is not sufficient)



Summary

- Declaration of conformity. 2
- Important warnings for safety 4
- Maintenance 7
- 1 Introduction 10
 - 1.1 Overview 10
- 2 Software Configurator 11
- 3 Quick Start 12
- 4 Basic Connections and sizing 13
- 5 Identification and Order Code 14
 - 5.1 Identification of the unit 14
 - 5.2 Order Code 15
- 6 Technical Specifications 16
 - 6.1 General features 16
 - 6.2 Input features 16
 - 6.3 Output features (power device) 16
 - 6.4 Environmental installation conditions 16
 - 6.5 Fan Specification 16
 - 6.6 Derating Curve 17
 - 6.7 Calculating flow capacity of the fan 17
- 7 Installation 18
 - 7.1 Dimensions and weight 19
 - 7.2 Fixing holes 19
- 8 Wiring instructions 20
 - 8.1 Command Terminals. 21
 - 8.2 Schematic 22
 - 8.3 Connection Diagram. 25
- 9 Control Panel. 26
 - 9.1 Menu navigation 27
 - 9.2 Led indicators 28
 - 9.3 Displayed alarms. 28
 - 9.4 Parameter list 29
- 10 Using the Configurator 41
 - 10.1 Typical Uses 41
 - 10.2 Communicating with Power Controllers 41
 - 10.3 Recipes 41
 - 10.4 How to 41

- 10.5 Using the Configurator 43
- 10.6 Software General information. 45
- 11** Configurable Inputs and Outputs. 52
 - 11.1 Digital Inputs 52
 - 11.2 Analog Input 1: Set Point 52
 - 11.3 Analog Input 2: Set Point, Feedback or Current Limit Set Point. 53
 - 11.4 Alarms and Alarm Relay Output. 53
- 12** Alarm description. 54
 - 12.1 Heater Break Alarm. 54
 - 12.2 AUX High 55
 - 12.3 AUX Low 55
 - 12.4 ComError 55
 - 12.5 AUX Line Loss 55
 - 12.6 Line Loss 55
 - 12.7 I Limit. 55
 - 12.8 SHRT 55
 - 12.9 SCR Temp 55
- 13** "Enable" Function in static Unit 56
 - 13.1 Using Digital Input only 56
 - 13.2 Using Serial Port RS485 only. 57
 - 13.3 Using Digital Input + Serial Port RS485 57
 - 13.4 Using FieldBus only 58
 - 13.5 Using Digital Input + FieldBus 59
- 14** Firing type. 60
 - 14.1 Zero Crossing. 60
 - 14.2 Single Cycle 60
 - 14.3 Burst Firing 60
 - 14.4 Soft Start with Burst Firing 61
 - 14.5 Phase Angle 61
 - 14.6 Soft Start with Phase Angle 61
 - 14.7 Delay Triggering with Burst Firing 62
 - 14.8 Half Cycle. 62
- 15** Heater bakeout function 63
 - 15.1 Using Heater Bakeout 63
- 16** Control Mode (feed-back) 64
- 17** Electronic boards 65
 - 17.1 Supply the Electronic Board 65
- 18** RS485 Serial port 66
 - 18.1 FIELD BUS Module 66
- 19** Internal Fuse 67

1

Introduction

A thyristor unit is semiconductor device which acts as a switch formed by two thyristors in antiparallel.

To switch on the alternating current the input signal will be on and the thyristor will switch off at first Zero Crossing voltage with no input signal.

The benefits of thyristor units compared with electromechanical contactors are numerous: no moving parts, no maintenance and capacity to switch very fast. Thyristors are the only solution to control transformers and special loads that change resistance with temperature and with age.

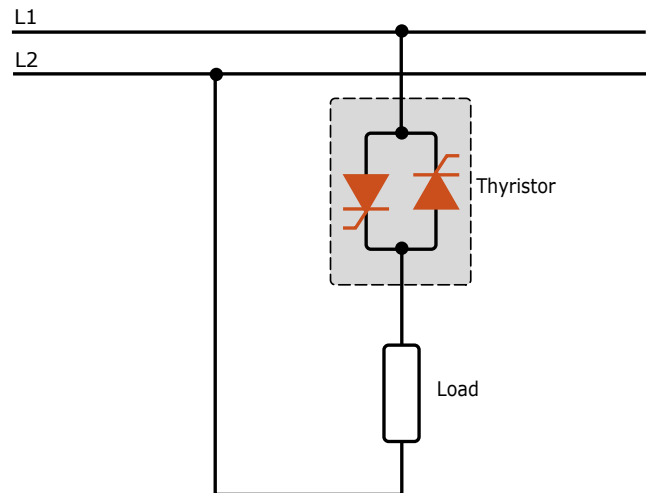

1.1 Overview

Heater bakeout

- Protects heater upon start up.
- Eliminates labor and time associated with checking for wet heaters.

Current transformer and user interface

- Saves installation time and eases setup and commissioning.
- Delivers a user-friendly, intuitive interface.

Industry-leading design and serviceability

- Offers a robust SCR design to meet a rugged industrial environment's high quality and reliability needs.
- Provides quick and easy access to maintain and service fuses and individual legs in minimal time.
- Enables fast troubleshooting by providing helpful thermal system diagnostics.

Comprehensive power controller range

- Provides wide range of options from simple single phase to complex three-phase loads to 600V.

100kA short circuit current rating (SCCR) (Not reviewed by UL®)

- Enables greater protection in the event of a short circuit.

c-UL® 508 Listed - PRELIMINARY, to be tested

- Shortens project schedules, agency testing and expenses.

Control modes: contactor, voltage, current or power

- Satisfies a wide range of demanding thermal applications.

Load firing modes: zero-cross, burst fire, phase angle, soft start, half-cycle, single-cycle, delayed triggering

- Handles a wide range of load types including nichrome, medium and long waveform infrared lamps, moly, transformers, silicon carbide, UV lamps and tungsten.
- Protects and extends the life of connected loads.

Wide range of communication protocols

- Enable factory and process automation with connectivity to process and equipment data via Modbus® RTU, Modbus® TCP, Profibus, Profinet (available with external master communication module).

Open heater and shorted SCR indication

- Minimizes production downtime with easy to understand, intelligent, troubleshooting diagnostics.

Integrated USB and user interface for configuration

- Easily and safely program configuration settings as the user interface can be powered through USB connection.
- Eliminates need to work in a high voltage hazard environment. High voltage to the power controller and system panel can be shut off and locked out for safety while configuring controller.

2 Software Configurator

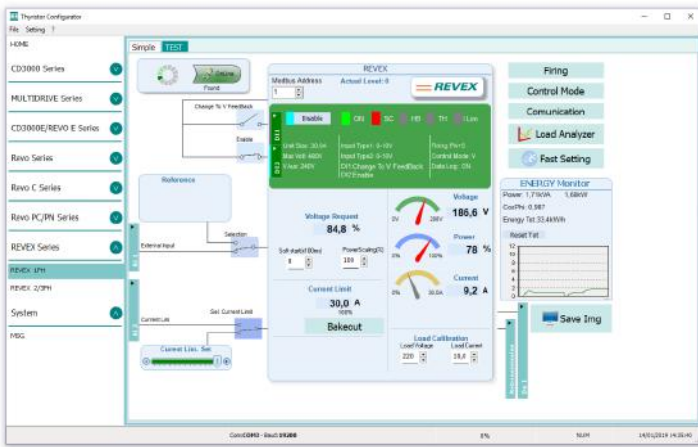

Thyristor configurator software is free and is possible download it from our site. If the Order Code is in line with requirement, then unit has been already configured in Factory and it's ready to use. You need the software only to modify the ordered configuration. Anyway we suggest to check the unit on the machine with the "Test unit" section. For install the software, launch the program and follow the instructions on the screen. Run the software configurator and set the correct serial port number by menu setting-serial com – port number.

Software Configurator download link:

https://www.cdautomation.com/wp-content/uploads/ThyristorConfigurator_ver6.zip

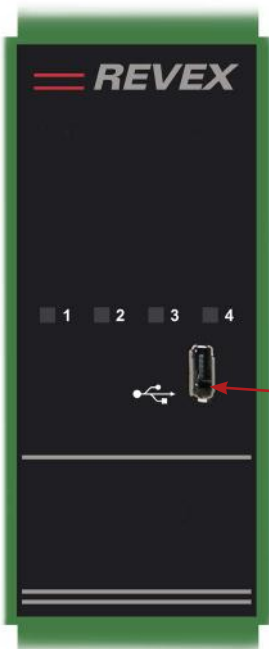

without display

Option code:
1/2/3/4/8/B/D/E
on digit 12



with display

Option code:
0/5/6/7/9/A/C/F
on digit 12

To connect the unit at the PC, it's necessary to use the micro USB 2.0 Modbus RTU cable. USB connection need a driver to work properly, you can find it from our site.

However the configuration software installer will install as default the correct driver.

Micro USB

3

Quick Start



Attention: this procedure must be carried out by skilled people only.

If your REVEX code is in line with what you really need, then the main configuration is already done by Producer and you just need to do the following steps:

1. Verify REVEX current sizing. Be sure that:
 - the load current is equal or less than the nominal one of REVEX
 - the main voltage is equal or less than the nominal voltage of REVEX
2. Verify the Installation
3. Verify the Wiring:
 - all auxiliary connections must be done in line with wirings on this manual
 - verify that there isn't a short circuit on the load
4. Supply the Unit
5. Set the parameters **Operative Load Voltage** and **Nominal Current of the load** by:
 - a. **REVEX Display version** (Option code 0/5/6/7/9/A/C/F on Digit 12)
using the frontal keypad --> Operator menu or Thyristor configurator software
 - b. **REVEX NO Display version** (Option code 1/2/3/4/8/B/D/E on Digit 12)
using Thyristor configurator software

The Unit is ready to work

The auxiliary voltage supply of the REVEX unit must be synchronized with load voltage power supply.

If the Auxiliary Voltage (written on the identification label) is different from Supply Voltage (to the load), use an external transformer.

IMPORTANT

Starting Strategy (Enable):

- 1: Feed the unit with L1-L2/N power voltage supply
- 2: Feed the auxiliary supply
- 3: Close the Enable contact to start with the regulation

If your REVEX code is NOT in line with what you really need, use the configurator software tool to set-up the unit. Install the software on your PC, select REVEX and click on test unit changing what you need.

4 Basic Connections and sizing

Single phase wiring with resistive load

$$I = \frac{P}{V}$$

- V = Nominal voltage of the load
- I = Nominal current of the load
- P = Nominal power of the load

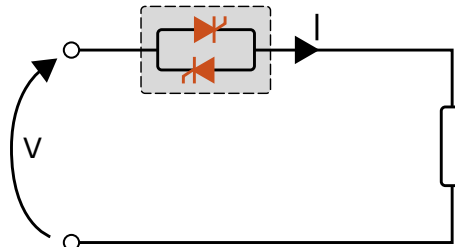

Single phase wiring with inductive load

$$I = \frac{P}{V \cos \varphi}$$

- V = Nominal voltage phase to phase
- I = Nominal current to the load
- P = Nominal power to the load

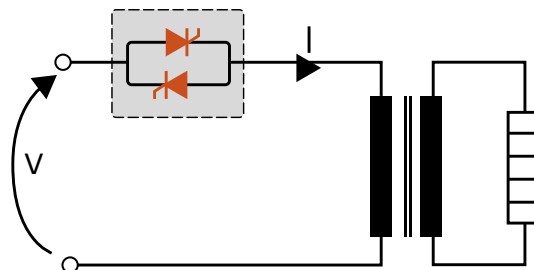

Open Delta wiring with resistive load

$$I = \frac{P}{3V}$$

- V = Nominal voltage of the load
- I = Nominal current of the load
- P = Nominal power of the load

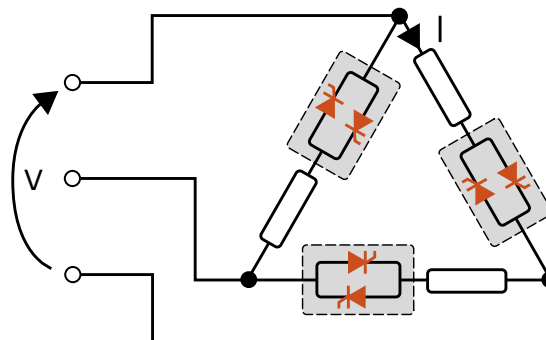

5 Identification and Order Code

5.1 Identification of the unit



Caution: Before to install, make sure that the Thyristor unit have not damages. If the product has a fault, please contact the dealer from which you purchased the product.

The identification label give all the information regarding the factory settings of the Thyristor unit, this label is on the unit, like represented in figure.

Verify that the product is the same thing as ordered.



without display

Option code:
1/2/3/4/8/B/D/E
on digit 12

with display

Option code:
0/5/6/7/9/A/C/F
on digit 12

5.2 Order Code

		1	2	3	4	5	6	7	8	9	10	11	12	13	14	15	16
REVEX 1PH		R	X	1	-	-	-	-	-	-	-	-	-	-	-	-	-
CURRENT		FUSES			4	5	6	CONTROL MODE				11					
description		description			code		note		description				code		note		
60A		Fixed Fuses Included			0 6 0				Open Loop				0				
90A		Fixed Fuses Included			0 9 0				Voltage				U				
									Voltage Square				Q				
									Current				I				
									Current Square				A				
									Power Vxl				W				
									External feedback				X				
MAX VOLTAGE					7				OPTION				12				
description					code		note		description				code		note		
480V					4				Option code see below table				...				
600V					6												
MAIN SUPPLY VOLTAGE					8				FAN VOLTAGE				13				
description					code		note		description				code		note		
24Vdc					4				No Fan < 90A				0				
									Fan 24Vdc ≥ 90A				3				
MAIN INPUT					9				APPROVALS				14				
description					code		note		description				code		note		
SSR					S				CE EMC For European Market				0				
0:20mA					B												
4:20mA					A												
0:10V					V												
10KPot					K												
FIRING		START OPTION			10				LOAD TYPE				15				
description		description			code		note		description				code		note		
Single Cycle		No Soft Start			C				1 PH Normal Resistance				0				
		Linear Soft Starter			S				1 PH IRSW Infrared Short Wave				1				
Half Cycle		No Soft Start			H				1 PH MoSi2 Heaters				2		2		
		Linear Soft Starter			L				1 PH SiC Heaters				3				
		Soft Start for short Infr. Lamp			I				1 PH Transformer Coupled with Normal Resistance				4		1		
Burst Firing		No Soft Start			B				1 PH Transformer Coupled with MoSi2 Heaters				5		1		
		Linear Soft Starter			J				1 PH Transformer Coupled with SiC Resistance				6		1		
Phase Angle		No Soft Start			P				1 PH Transformer Coupled with UV Lamp				7		1		
		Linear Soft Starter			E												
Delayed Triggering		No Soft Start			D												
		Linear Soft Starter			T												
Zero Crossing		No Soft Start			Z												
		Linear Soft Starter			R												
									VERSION				16				
									description				code		note		
									N*1 Modbus® RTU std.				0				

Note (1): This configuration is possible only with Delayed Triggering or Phase Angle Firing

Note (2): This configuration is possible only with Phase Angle Firing

5.2.1 Option Code for Digit 12

Current Limit	Heater Break	Fuse	Display	Option Code
Y	Y	Y	Y	0
Y	Y	Y	N	1
Y	Y	N	N	2
Y	N	N	N	3
N	N	N	N	4
Y	Y	N	Y	5
Y	N	N	Y	6
N	N	N	Y	7
N	Y	Y	N	8
N	Y	N	Y	9
N	N	Y	Y	A
N	N	Y	N	B
N	Y	Y	Y	C
N	Y	N	N	D
Y	N	Y	N	E
Y	N	Y	Y	F

Y Present
N Not present

6 Technical Specifications

6.1 General features

Cover and Socket material: PolymericV2
 Utilization Category: AC-51 AC-55b AC-56A
 IP Code: 20
 Method of Connecting: Single Phase load
 Auxiliary voltage
 Order Code RX1____-4: 24Vdc 1A
 Relay output for Heater Break Alarm (only with HB option) 0.5A a 24Vac/dc

6.2 Input features

Digital Input: 4 ÷ 30Vdc 5mA Max (ON ≥ 4Vdc OFF < 1Vdc) 5Hz max
 Volt Analogic input: 0 ÷ 10Vdc impedance 15 kΩ
 Current Analogic input: 4 ÷ 20mA impedance 100 Ω
 Potentiometer: 10 kΩ min.
 Logic input SSR (Fast Enable): 4 ÷ 30Vdc 5mA Max (ON ≥4Vdc OFF <1Vdc) 3Hz Max duty cycle min. 100 ms

6.3 Output features (power device)

Current	Nominal Voltage range (Ue)	Repetitive peak reverse voltage (Uimp)	Latching current	Max peak one cycle	Leakage current	Fuse I ² T value Suggested A2s (at500V)	Frequency range	Power loss Thyristor + Fuse	Isolation Voltage (Ui)
(A)	(V)	(600V)	(mAeff)	(10 msec.) (A)	(mAeff)	tp= 10msec	(Hz)	I =Inom (W)	(Vac)
60	24÷600	1600	600	1900	15	4305	47÷70	102	3000
90	24÷600	1600	600	1900	15	4305	47÷70	145	3000

6.4 Environmental installation conditions

Ambient temperature 0-40°C (32-104°F) at nominal current. Over 40°C-104°F use the derating curve (max 50°C).
 Storage temperature -25°C to 70°C -13°F to 158°F
 Installation place Don't install at direct sun light, where there are conductive dust, corrosive gas, vibration or water and also in salty environmental.
 Altitude Up to 1000 meter over sea level. For higher altitude reduce the nominal current of 2% for each 100m over 1000m
 Humidity From 5 to 95% without condense and ice
 Pollution Level Up to 2nd Level ref. IEC 60947-1 6.1.3.2

6.5 Fan Specification

Supply: 24 Vdc Power 7W (1 Fan)

6.6 Derating Curve

The nominal current of the units in specification are referred to continuous service at 40°C ambient temperature. For higher temperature multiply the nominal current times derating coefficient K below represented:

$$I_{max} = I_{nominal} \times K$$

● Derating

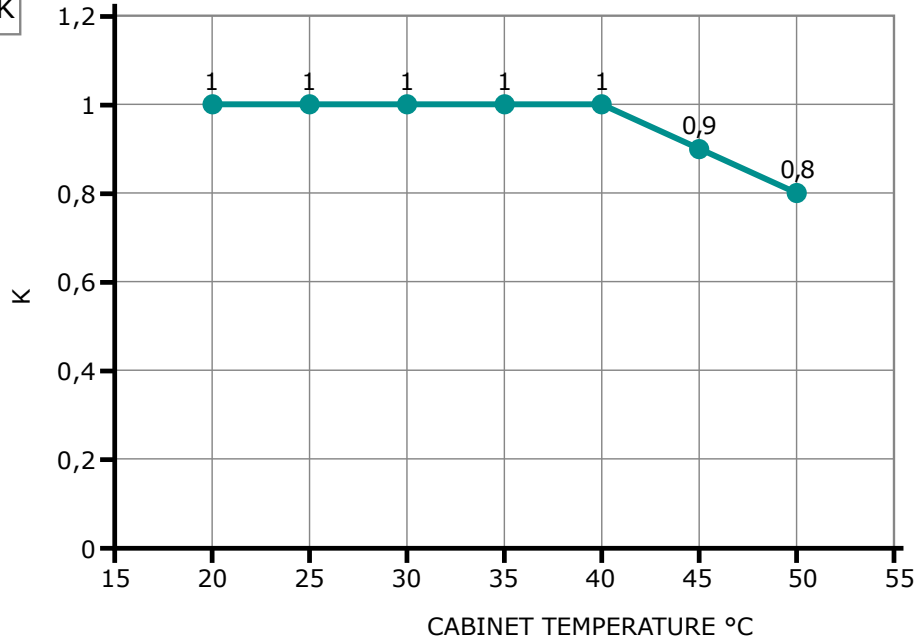

For higher cabinet temperature (more than 50°C) contact the producer of the unit

6.7 Calculating flow capacity of the fan

All the thyristor units when are in conduction produces power loss that is dissipated inside cubicle in terms of heating. Due to this fact the internal temperature of cubicle is higher than ambient temperature. To be cooled the thyristor need of fresh air cooling and to do it is normally used a fan mounted on the front door or on the roof of the cabinet.

Procedure to size **Fan air mass flow (V)**: see power loss for each thyristor and fuse mounted indicated in the manual related to the current (Output feature and Internal fuse Chapter).

$V = f * \frac{Q_v}{t_c - t_a}$	Q_v = total power losses (w) (thyristor + fuse power loss)	Altitude 0:100 meters f = 3.1 m ³ k/W/h 100:250 meters f = 3.2 m ³ k/W/h 250:500 meters f = 3.3 m ³ k/W/h 500:750 meters f = 3.4 m ³ k/W/h
	t_a = ambient temperature (°C) t_c = cabinet temperature (°C) V = fan air mass flow (m ³ /h) f = altitude coefficient (see table on right)	



The formulas used are for information only and is not a substitute for a proper thermal rating done by a qualified person.

7 Installation

Before to install, make sure that the Thyristor unit have not damages.

If the product has a fault, please contact the dealer from which you purchased the product. Verify that the product is the same thing as ordered.

The Thyristor unit must be always mounted in vertical position to improve air cooling on heat-sink.

Maintain the minimum distances (*) in vertical and in horizontal as represented, *this area must be free from obstacle (wire, copper bar, plastic channel).*

When more unit has mounted inside the cabinet maintain the air circulation like represented in figure without obstacle for the air flow.

Is necessary to install a fan to have better air circulation as calculated previously.

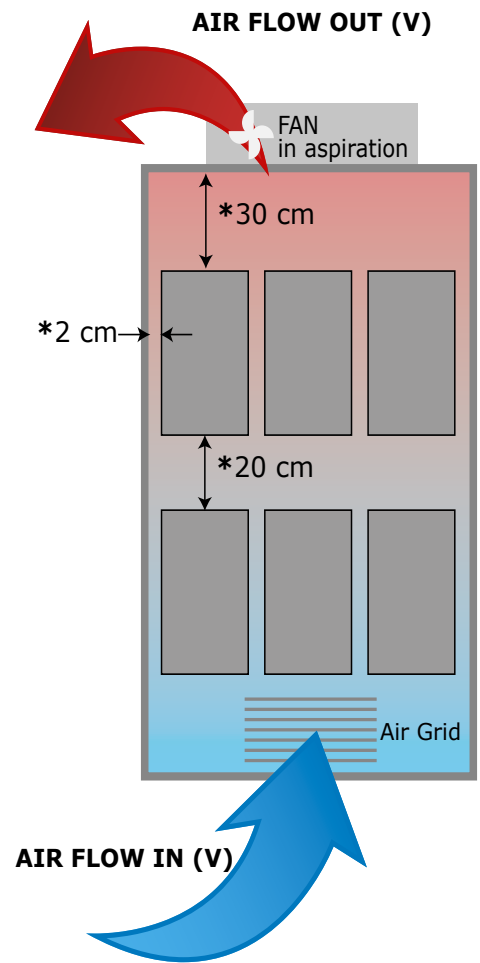

The V Air flow must be equal or more than the value calculated.

If the cabinet fan mounted by the customer have an air flow lower than the correct value the warranty will decay.

7.1 Dimensions and weight

Size SR24 (1PH 60A)

W (mm) 116 - H (mm) 169 - D (mm) 183

Weight (kg) 2,10

Size SR25 (1PH 90A)

W (mm) 116 - H (mm) 180 - D (mm) 183

Weight (kg) 2,35

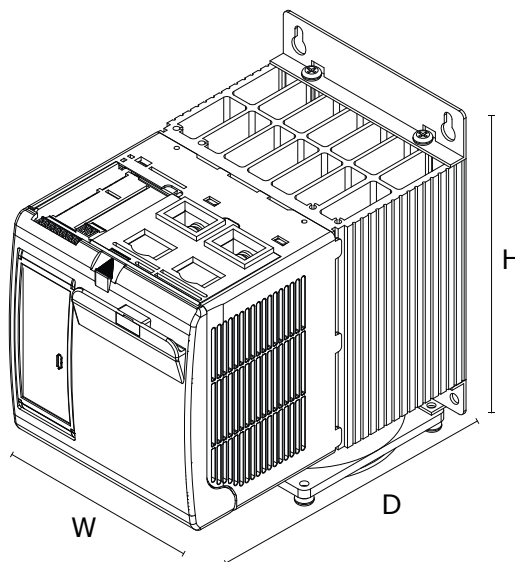
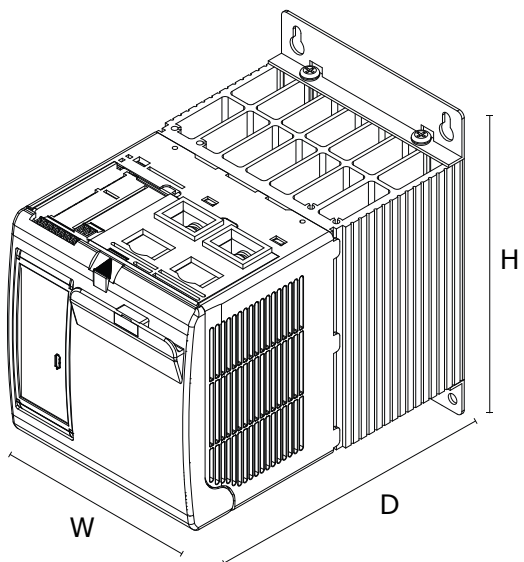

7.2 Fixing holes

Size SR24 (1PH 60A)

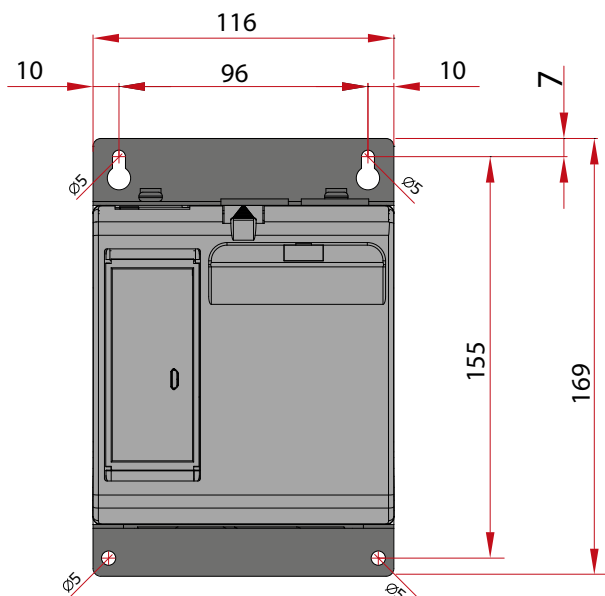

Size SR25 (1PH 90A)

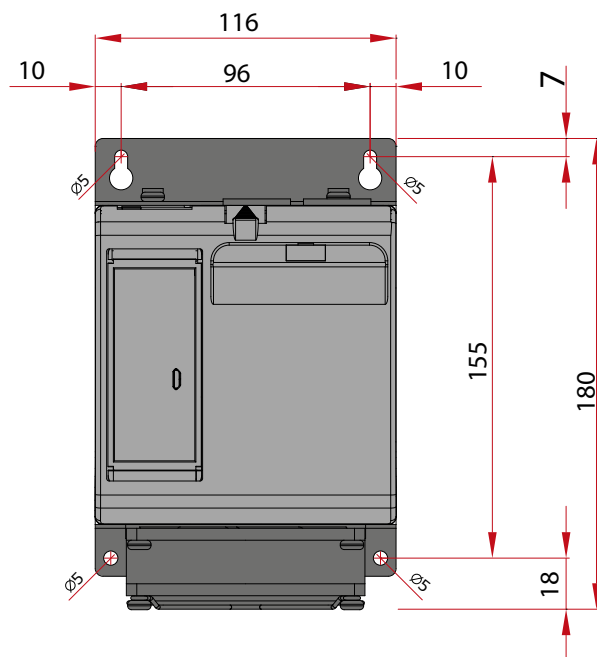

8 Wiring instructions

The Thyristor unit could be susceptible to interferences lost by near equipments or by the power supply, for this reason in accord to the fundamental practices rules is opportune take some precautions:

- The coil contactor, the relays and other inductive loads must be equipped with opportune RC filter.
- Use shielded bipolar cables for all the input and output signals.
- The signal cables must not be near and parallel to the power cables.
- Local regulations regarding electrical installation should be rigidly observed.

Use 90°C copper (CU) conductor only, wire ranges (AWG), wire terminal type (ZMVV), terminal tightening torque in the table below.

Power cable torque (suggested):

Type	Connector Type	Torque Lb-in (N-m)	Wire Range mm ² (AWG)	MAX Current Terminals	Wire Terminals UL Listed (ZMVV)
060 090	Screw M6	44.2 (5.0)	18 (5) 25 (3)	90A	Fork/Spade Terminal Copper Tube Crimp.Lug

Cable dimensions of the Command Terminals	0.5 mm ² (AWG 18)
Cable dimensions of the Earth (suggested)	6 mm ² (AWG 10)



Warning: Before connecting or disconnecting the unit check that power and control cables are isolated from voltage sources.

Terminal	Description
L1	Line Input Phase 1
T1	Load Output Phase 1

8.1 Command Terminals



Warning: Before connecting or disconnecting the unit check that power and control cables are isolated from voltage sources.

8.1.1 Terminal block M1

Terminal	Description
Sync.	Zero crossing synchronization
Sync.	Zero crossing synchronization (not connected, see note below)

Note: both terminals are connected internally and may be possible to use any one of them.

8.1.2 Terminal block M2

Terminal	Description
8	GND
9	COM I - Common Digital Input
10	DI 2 - Enable Digital Input
11	DI 1 - Configurable Input
12	+ Analog Input 1 (0-10Vdc/4-20mA Analog Setpoint)
13	- for Analog Input 1 and Analog input 2 - 0 Volt
14	Output +10Vdc stabilized 1 mA MAX
15	+ Analog Input 2 (0-10Vdc/4-20mA Analog Setpoint)

8.1.3 Terminal block M3

Terminal	Description
1	Auxiliary - 24Vdc 1A Input power supply for communication
2	Auxiliary + 24Vdc 1A Input power supply for communication
3	RS485 A+
4	RS485 B-
5	C - Common contact alarm relay output
6	NO - Normally Open contact alarm relay output (SC/HB)
7	NC - Normally Close contact alarm relay output (SC/HB)

8.2 Schematic



Indicative connection diagrams. Refer to local regulations for proper system protection.



Warning: It is not possible to remove the M3 connector when the unit is powered. Remove the AUX 24Vdc power supply before extracting the M3 connector. Extracting the M3 connector with the AUX 24Vdc power supply connected to the M3 terminal could damage the unit

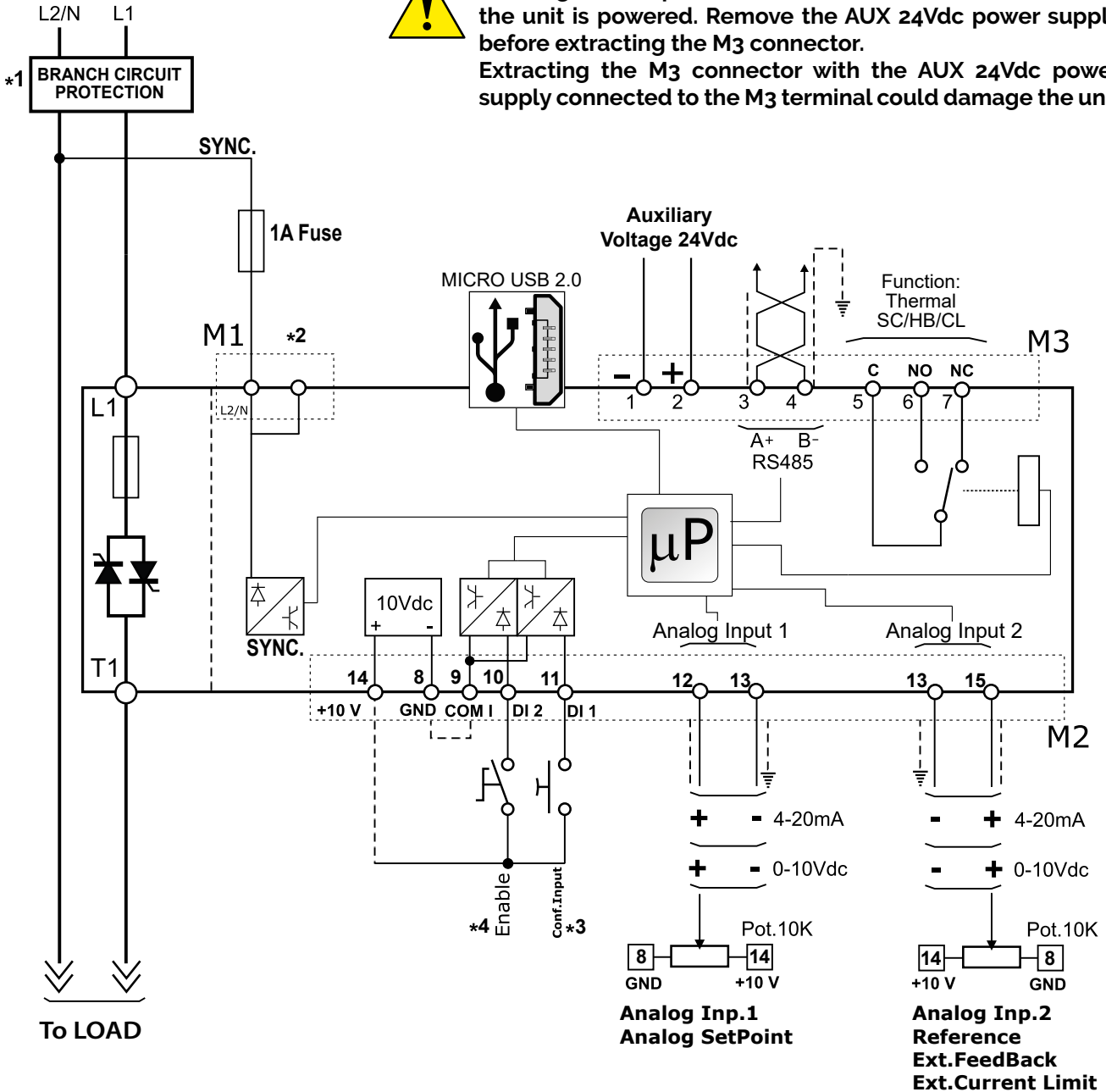

NOTE:

- *1 The user installation must be protecting by electromagnetic circuit breaker or by fuse isolator. The Fuse must be branch circuit protection.
- *2 **Connect on the phase not controlled by the thyristor, L2/N on Schematic above. Both terminals are connected internally and may be possible to use any one of them.**
- *3 For SSR input connection follow next page schematic.
- *4 **IMPORTANT! Starting Strategy (Enable):**
 - 1: Feed the unit with L1-L2/N power voltage supply
 - 2: Feed the auxiliary supply
 - 3: Close the Enable contact to start with the regulation

8.2.1 SSR Control Input schematic

For SSR input use follow the schematic below and configure Digital Input 1 as Fast Enable.

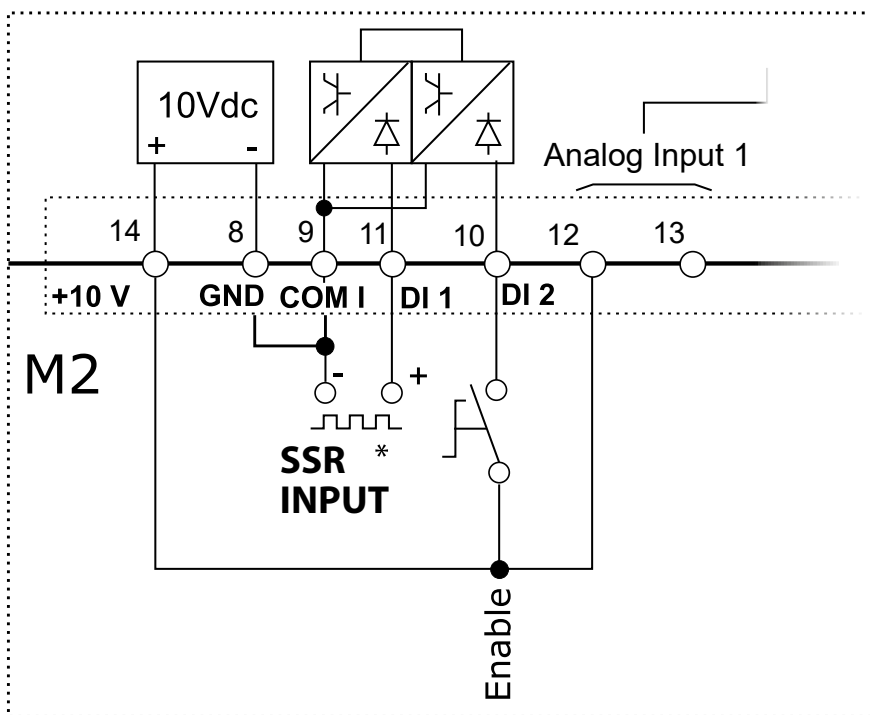

* **SSR Input:** 4 ÷ 30Vdc 5mA Max (ON ≥4Vdc OFF <1Vdc)
 3Hz Max on time min. 100 ms

TOP VIEW

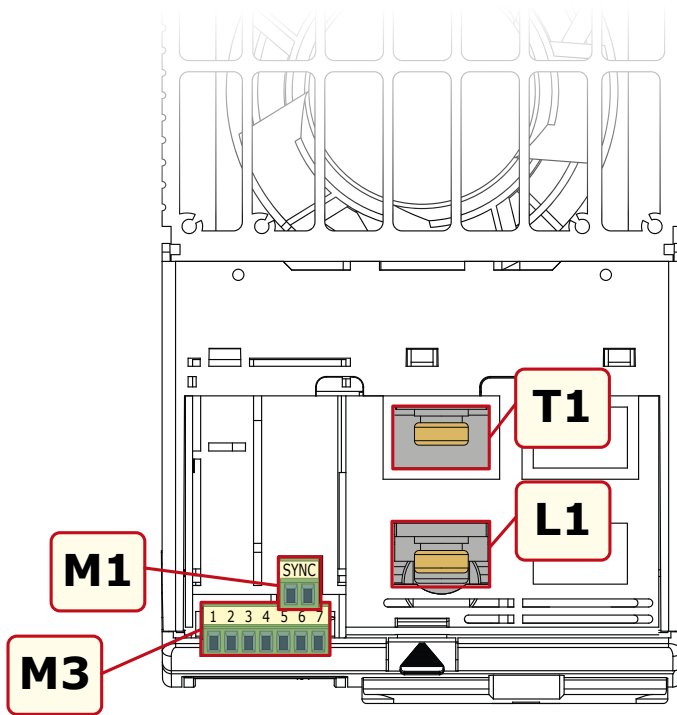

DOWN VIEW

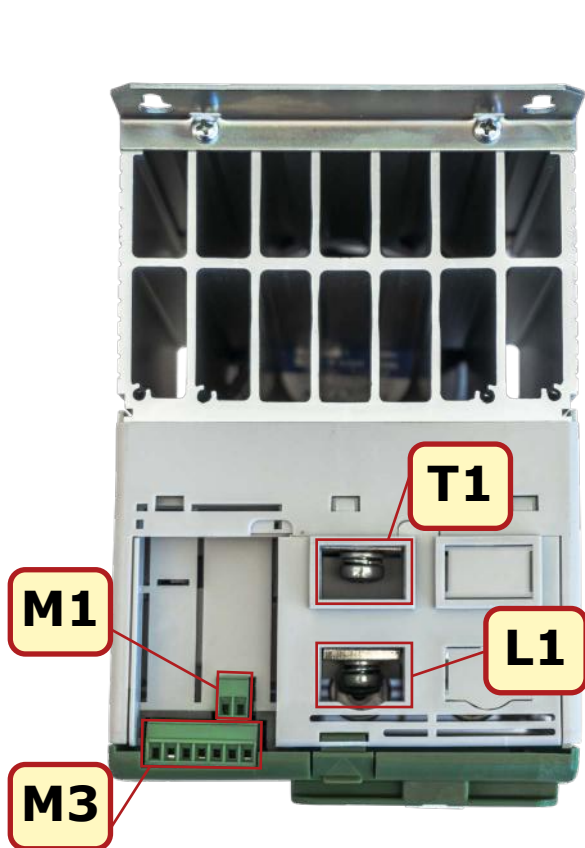
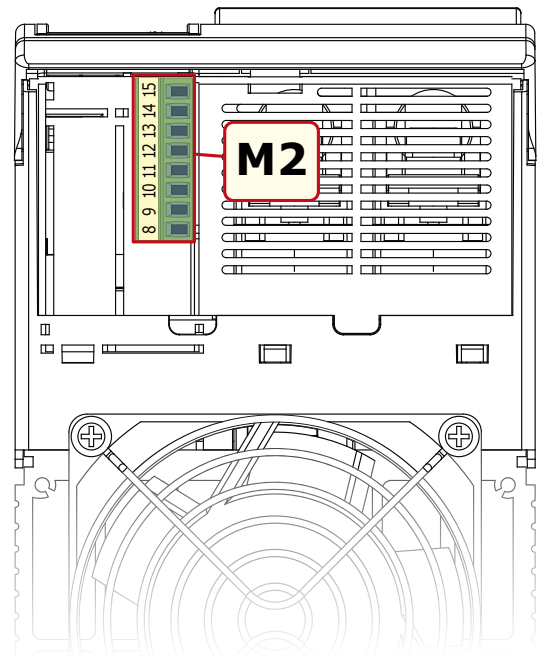

8.3 Connection Diagram

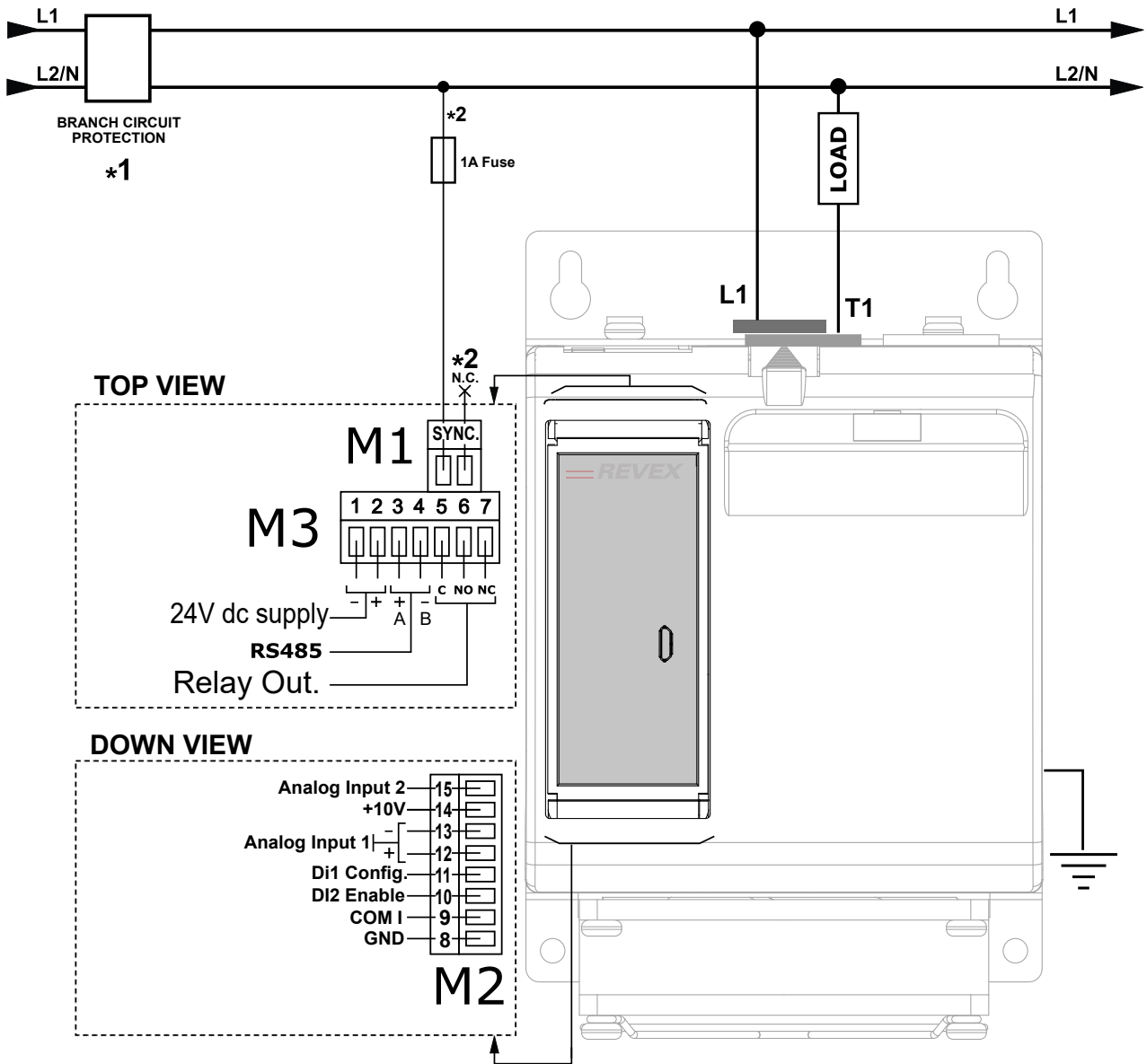

Warning: It is not possible to remove the M3 connector when the unit is powered. Remove the AUX 24Vdc power supply before extracting the M3 connector. Extracting the M3 connector with the AUX 24Vdc power supply connected to the M3 terminal could damage the unit

NOTE:

*1 The user installation must be protecting by electromagnetic circuit breaker or by fuse isolator. The Fuse must be branch circuit protection.

*2 Connect on the phase not controlled by the thyristor, L2/N on schematic above Both terminals are connected internally and may be possible to use any one of them.

9 Control Panel

i Control Panel Display and Keys are Not present for Option Codes: 1/2/3/4/8/B/D/E (see table pag. 15)

The Control Panel is placed on the front of the thyristor unit, on his display you can visualize the alarms, the input and output signals and all the configuration parameters.

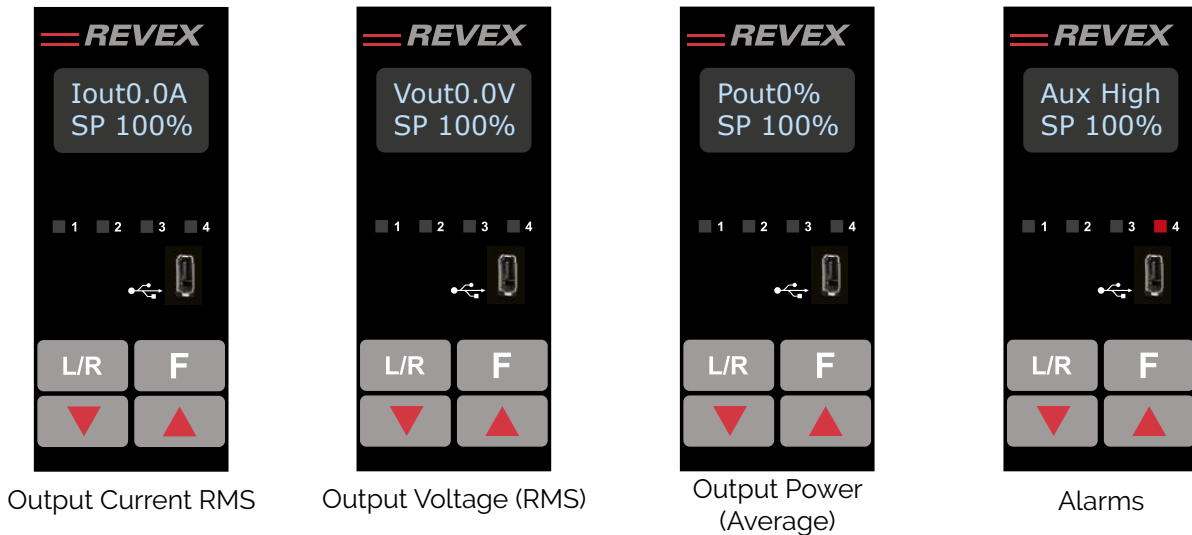

On the home page the keys are used as follows:

Press...		to...
F	Function	Scroll through the parameters on the home page
L/R	Local/Remote	Switch between local and remote set point for power demand
▼	Up	Increment power demand set point when set to local
▲	Down	Decrement power demand set point when set to local
F + L/R		Press and hold for about two seconds to access the menus

To view the status parameters:

- Press Function **F** once to advance from one parameter to the next

To set the set point locally:

- Press Local/Remote **L/R** (Note: indicator 1 flashes steadily when set point is set locally)
- Use Down **▼** and/or Up **▲** to set the local set point.

9.1 Menu navigation

The menus are accessible using the control panel keypad and display.

i Control Panel Display and Keys are Not present for Option Codes: 1/2/3/4/8/B/D/E (see table pag. 15)

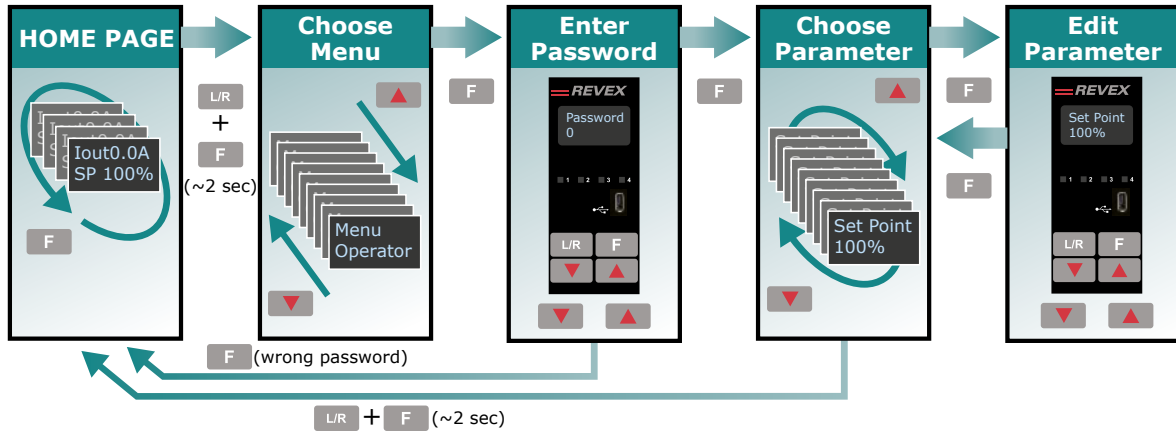

To access a menu and edit a setting:

1. Press and hold Local/Remote and Function together **L/R** + **F** until the upper display flashes Menu.
2. Press Up **▲** to choose the menu. (Press down **▼** if you overshoot the menu you want).
3. Press function **F** to advance to the password prompt.
4. Use up **▲** and/or down **▼** to set the password (see the table).
5. Press function **F** to enter the password and advance to the first parameter of the menu.
6. Press Up **▲** to advance to the next parameter and repeat to reach the desired parameter.
7. Press function **F** to start editing the parameter. The parameter name flashes in the upper display.
8. Use Up **▲** and/or down **▼** to edit the parameter setting.
9. Press function **F** to enter the new setting. The parameter name stops flashing.
10. Press and hold local/remote and function together **L/R** + **F** for about two seconds to exit the menus.

Menu	Password	Parameter used to...
Operator	0	View measured values and basic settings including current, voltage and set point
Setup	2	Configure the power controller for the load
Adv Setup	10	Configure the operation and performance of the power controller in the application
Hardware	5	Configure the functions of the analog and digital inputs and outputs, and the re-transmission parameters
Comm	3	Configure field bus communicating parameters
Monitoring	0	View measured and calculated values and other read-only parameters

9.2 Led indicators

The four indicators on the control panel show the general state of the power controller.

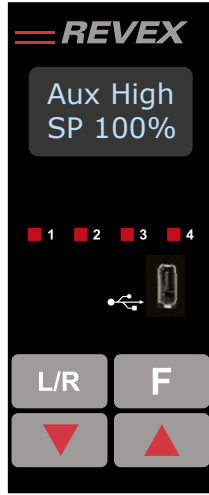
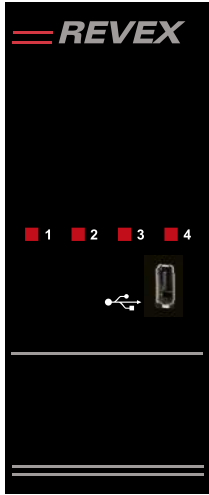

1	Local/Remote	Flashing	Power output set locally or via communications
		Off	Power output set remotely (via analog input)
2	Enable	On	Output enabled
		Off	Output disabled
3	Communications	Flashing	Active communications
4	Alarm	Flashing	Active alarm*
		Off	No alarm

without display
Option code:
1/2/3/4/8/B/D/E
on digit 12

with display
Option code:
0/5/6/7/9/A/C/F
on digit 12

*In the version without display, Led 4 lit indicates that one of the alarms shown in the table below is active. Connect the configurator and check on the Test page which alarm is active.

9.3 Displayed alarms

i Control Panel Display and Keys are Not present for Option Codes: 1/2/3/4/8/B/D/E (see table pag. 15)

Alarm or	Message	Description
HeatBrk		Heater Break (if available)
Aux High		Aux voltage too high
Aux Low		Aux voltage too low
	BakeOut	Heater Bakeout function active
ComError		Communication Watchdog error
Aux Line Loss		Auxiliary voltage (24V) not present
Line Loss		Line power not detected
I Limit		Output limited by current limit feature (only single phase) (if available)
SHRT		Short Circuit on SCR
SCR Temp		Thermal Switch over temperature

i If you have the version without display, all the functions shown on the display can be viewed via the configurator

9.4 Parameter list

i Control Panel Display and Keys are Not present for Option Codes: 1/2/3/4/8/B/D/E (see table pag. 15)

This chapter describes the parameter on the menus accessed via the control panel and Configurator software. To learn how to access the menus described below see "Menu navigation" chapter.

Menu Listing

The table below lists the parameters found on each menu. See the following pages for descriptions and other details of each parameter.

Operator	Setup	Advanced Setup	Hardware	Communication	Monitoring
Set Point	Out Scale	Firing Type	Analog in 1	Port 1 Baud	Dig in 1
Volts Out	I Limit SP	Min Cycle	Analog in 2	Port 1 Addr	Dig in 2
Current	Nom Line V	Soft Start	An2 Funct	Watchdog	Enable
Power	Nominal I	Start Ramp	D11 Functn	WD Reset	SP Source
Volts In	Soft Start	Delay	D12 Functn		Analog In1
Frequency	SP Select	Cycle Time	Alm Out Fn		Analog In2
Pwr Factor		Feedback	IL SP Src		SW Ver
Load Ω		Pb Power	Start Disp		SW Rel
I Limit SP		Ti Power			Unit Type
Out Scale		Pb Current			Max Voltage
Nom Line V		Ti Current			Max Current
Nominal I		HB Sense			Aux Voltage
		HB Delay			Serial No.
		Htr Bake			SCR Temp

Read/write Read only

9.4.1 Operator Menu

This section describes each item on the operator menu. Use this menu to view the measured values and basic settings of the power controller. **The password to access this menu is 0.**

Parameter Name	Description	Range	Unit	Modbus Address	Par. Type
Set Point	View the set point	0 to 100	%	15	Read Only
Volts Out	Indicates the average (RMS) voltage of all phases	0 to 1023	V	10	Read Only
Current	Indicates the average (RMS) current of all phases	0 to 1023	V	11	Read Only
Power	Indicates the average (RMS) power output	0 to 100	%	12	Read Only
Volts In	Indicates the average (RMS) voltage input	0 to 65535	V	47	Read Only
Frequency	Indicates frequency of the power input	0 to 655.35	Hz	9	Read Only
Pwr Factor	Indicates power factor of the output power	0 to 1000		102	Read Only
Load Ω	Indicates the resistance of the load	0 to 655.35	Ω	46	Read Only
I Limit SP	Indicates the maximum percent of the nominal current that the power control allows. This parameter indicates RMS current by default. When parameter 52 is set to 1, this parameter indicates peak current	0 to 100	%	17	Read Only
Out Scale	Indicates the percentage by which the power demand set point is scaled	0 to 100.0	%	16	Read Only
Nom Line V	Indicates the user-set, nominal value for the line voltage input	0 to 1023	V	37	Read Only
Nominal I	Indicates the user-set, nominal load current	0 to 999.9	A	38	Read Only

9.4.2 Setup Menu

This section describes each item on the setup menu. Use this menu to configure the power controller for the load. **The password to access this menu is 2.**

Parameter Name	Description	Range	Unit	Modbus Address	Par. Type
Out Scale	Set the percentage by which the set point is scaled. For example, if a 0 to 10V analog input providing the set point is 5V and output scaling is 80% then the effective set point is 40%	0 to 100.0	%	16	Read Write

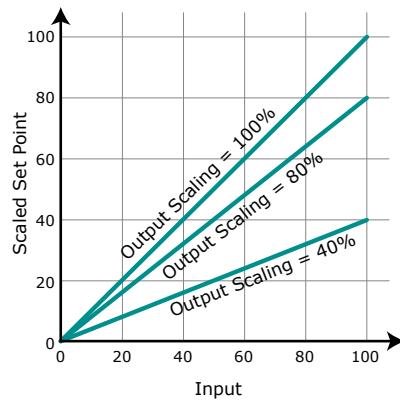

Parameter Name	Description	Default	Range	Unit	Modbus Address	Par. Type
I Limit SP	Set the maximum percent of the nominal current that the power control allows. This parameter indicates RMS current by default. When parameter 52 is set to 1, this parameter indicates peak current	100%	0 to 100.0	%	17	Read Write
Nom Line V	Set the nominal value for the line voltage input	220V	0 to 1023	V	37	Read Write
Nominal I	Set the nominal load current	Maximum current	0 to 999.9	A	38	Read Write
Soft Start	Set the duration of the soft start in increment of 100mSec. The power controller ramps set to point changes over the time set here. For more information see "Firing type" page: Soft Start with Burst Firing and Soft Start with Phase Angle	100 (10 sec)	0 to 255 (0 to 25.5 sec)		23	Read Write
SP select	Choose the source for the remote set point	0			61	Read Write

Option	Value
Analog In 1	0
Analog In 2	1

9.4.3 Advanced Setup Menu

This section describes each item on the advanced setup menu. Use this menu to configure the power switching, closed loop control of power and adjustable settings for data logging and heater bakeout. **The password to access this menu is 10.**

Parameter Name	Description	Default	Modbus Address	Par. Type
Firing Type	Choose the firing mode	3	18	Read Write

Option	Value
Zero Cross	1
Single Cyc	2
Burst fire	3
Ph Angle	4
Burst StrtR	19
PA SoftS	20
Delay Trig	35
Half Cycle	10
DEFAULT: Burst Fire	3

Parameter Name	Description	Default	Range	Unit	Modbus Address	Par. Type
Min Cycles	Set the minimum number of On cycles and off cycles for burst firing	8	0 to 999.9	n°	20	Read Write
Soft Start	Set the duration of the soft start in increment of 100mSec. The power controller ramps set to point changes over the time set here. For more information see "Firing type" page: Soft Start with Burst Firing and Soft Start with Phase Angle	100 (10 sec)	0 to 255 (0 to 25.5 sec)		23	Read Write
Start Ramp	Set the number of half cycles over which the power ramps each time the output turns on	0	0 to 1024	n°	25	Read Write
Delay	Set the firing delay degrees. Applies to burst firing with delay trigger	1	1 to 255	°	22	Read Write
Cycle time	Set the duration of one on-off cycle in increments of 50mSec. Applies to zero crossing	60 (3 sec)	0 to 255 (0 to 12.75 sec)		24	Read Write

Parameter Name	Description	Default	Range	Unit	Modbus Address	Par. Type
Feedback	Choose the feed-back type	1			19	Read Write

Option	Description	Value
V²	Voltage squared	0
None	No feed-back	1
I²	Current squared	2
Voltage	Voltage	32
Current	Current	64
Power	Power	128
External	External signal via analog input 2	256
DEFAULT: None		1

Parameter Name	Description	Default	Range	Unit	Modbus Address	Par. Type
Pb Power	Set the gain for the main loop. A larger value yields a larger adjustment for a given deviation	10%	0 to 255	%	26	Read Write
Ti Power	Set how aggressively the integral part of the control algorithm acts. A larger settings yields a larger adjustment for a given deviation over a given time	50	0 to 255		27	Read Write
Pb Current	Set the gain for the current loop. A larger value yields a larger adjustment for a given deviation	10%	0 to 255	%	63	Read Write
Ti Current	Set how aggressively the integral acts in the current loop. A larger settings yields a larger adjustment for a given deviation over a given time	50	0 to 255		64	Read Write
HB Sense	Set the threshold of resistance that activates the Heater Break alarm. This setting is in percentage of the nominal load resistance	100%	0 to 100.0	%	29	Read Write

Parameter Name	Description	Default	Range	Modbus Address	Par. Type
HB Delay	Set a delay between when the resistance drops below the value set for a heater break sensitivity and when the heater break alarm is indicated. This set increments of 50mSec	50 (2.5 sec)	0 to 255 (0 to 12.75 sec)	28	Read Write
Htr Bake	Enable or disable the heater bakeout feature	0		140	Read Write

Option	Value
Off	0
On	1
DEFAULT: Off	0

9.4.4 Hardware Menu

This section describes each item on the hardware menu. Use this menu to configure how the inputs and outputs are used in the application. **The password to access this menu is 5.**

Parameter Name	Description	Default	Modbus Address	Par. Type
Analog In 1	Choose the type of signal to be measured by analog input 1	1	44	Read Write

Option	Description	Value
0-10V	0 to 10 Vdc or 10,000Ω	1
4-20mA	4 to 20 mAdc	2
0-20mA	0 to 20 mAdc	3
DEFAULT: 0-10V		1

Parameter Name	Description	Default	Modbus Address	Par. Type
Analog In 2	Choose the type of signal to be measured by analog input 2	1	105	Read Write

Option	Description	Value
0-10V	0 to 10 Vdc or 10,000Ω	1
4-20mA	4 to 20 mAdc	2
0-20mA	0 to 20 mAdc	3
DEFAULT: 0-10V		1

Parameter Name	Description	Default	Modbus Address	Par. Type
An2 Funct	Choose how the signal measured by analog input 2 is used	0	116	Read Write

Option	Description	Value
I Limit SP	Current Limit Set point	0
Feedback	External feed-back	1
Set Point	Power Demand set point	2
DEFAULT 1Phase: I Limit		0

Parameter Name	Description	Default	Modbus Address	Par. Type
D11 Functn	Choose how the signal detected by digital input 1 is used	2	32	Read Write

Option	Description	Value
Enable	Enable power output	0
V Feedback	Use voltage feed-back when on	2
Local / Rmt	Local when on / Remote when off	3
Ph Angle	Use phase angle firing when on	4
SP AI1/AI2	Select remote set point source: analog input 1 when off or analog input 2 when on	5
Htr Bake	Enable heater bakeout	7
FastEn	Fast Enable*	8
DEFAULT: Voltage Feed-back		2

* **SSR Input:** 4 ÷ 30Vdc 5mA Max (ON ≥4Vdc OFF <1Vdc) 3HZ Max on time min. 100 ms
 When the Fast Enable input is enabled, Phase Angle firing is automatically selected.

Parameter Name	Description	Default	Modbus Address	Par. Type
D12 Functn	Choose how the signal detected by digital input 2 is used	0	33	Read Write

Option	Description	Value
Enable	Enable power output	0
V Feedback	Use voltage feed-back when on	2
Local / Rmt	Local when on / Remote when off	3
Ph Angle	Use phase angle firing when on	4
SP AI1/AI2	Select remote set point source: analog input 1 when off or analog input 2 when on	5
Htr Bake	Enable heater bakeout	7
FastEn	Fast Enable*	8
DEFAULT: Enable		0

* **SSR Input:** 4 ÷ 30Vdc 5mA Max (ON ≥4Vdc OFF <1Vdc) 3HZ Max on time min. 100 ms
 When the Fast Enable input is enabled, Phase Angle firing is automatically selected.

Parameter Name	Description	Default	Modbus Address	Par. Type
Alm Out Fn	Choose for which conditions the digital output indicates alarm. The output always indicate an alarm when the heat sink is over temperature. The digital output is energized for normal operating condition and de-energized when the power controller is off or when there is an alarm. Note!: The power controller monitors for heater break or short circuit condition only when included in the option selected for Alarm Output Function	1	34	Read Write

Option	Description	Bit
Heater Break	Heater Break	0
Short Circuit	Short circuit	1
Current Limit	Current Limit	2
Therm	SCR is over temperature	3
Communication	Communication watchdog error	4
DEFAULT		None

Alarm Bitwise is allowed

Parameter Name	Description	Default	Modbus Address	Par. Type
IL SP Src	Choose how the current limit is set	16	14, bit 4	Read Write

Option	Description	Value
Local / Comms	Set point set via keypad or communication	16
Analog In 2	Set point set via analog input	0
DEFAULT: Local / Comms		16

Parameter Name	Description	Default	Modbus Address	Par. Type
Start Disp	Choose which parameter is displayed on the home page at power-up	1	60	Read Write

Option	Value
Current	0
Volts Out	1
Power	2
DEFAULT: Voltage	1

9.4.5 Communication Menu

This section describes each item on the communication menu. Use this menu to configure the communication options. **The password to access this menu is 3.**

Parameter Name	Description	Default	Modbus Address	Par. Type
Port 1 Baud	Choose the baud rate for the primary serial port	2	30	Read Write

Option	Value
9600	0
19.2K	1
38.4K	2
115.2K	3
DEFAULT: 38.4K	2

Parameter Name	Description	Default	Range	Modbus Address	Par. Type
Port 1 Addr	Set the address for the primary serial port	1	0 to 255	31	Read Write
Watchdog	Enable or disable the watchdog on the primary serial port	0		142	Read Write

Option	Value
Off	0
On	1
DEFAULT: Off	0

Parameter Name	Description	Default	Range	Unit	Modbus Address	Par. Type
WD Reset	Set the amount of time to wait for a message before triggering the watchdog error. This function is available only for Modbus RTU Protocol	5	0 to 255	Sec	143	Read Write

9.4.6 Monitoring Menu

This section describes each item on the monitoring menu. Use this menu to view the states of digital input, values of analog input and information about the power controller such as serial number and software version. **The password to access this menu is 0.**

Parameter Name	Description	Modbus Address	Par. Type
Dig In 1	Indicate the state of the signal to digital input 1	13 bit8	Read Only

Option	Value
Off	0
On	1

Parameter Name	Description	Modbus Address	Par. Type
Dig In 2	Indicate the state of the signal to digital input 2	13 bit9	Read Only

Option	Value
Off	0
On	1

Parameter Name	Description	Modbus Address	Par. Type
Enable	Indicate whether or not the power controller is enabled. The enable signal must be on for the unit to output power to the load	14 bit2	Read Only

Option	Value
Off	0
On	1

Parameter Name	Description	Modbus Address	Par. Type
SP Source	Indicate whether the power controller is local or remote set point mode	14 bit1	Read Only

Option	Description	Value
Local / Comms	Set Point via keypad or communication	2
Remote	Set Point via analog input	0

Parameter Name	Description	Range	Unit	Modbus Address	Par. Type
Analog In1	Indicates the percent of full scale measured by analog input 1	0 to 100.0	%	138	Read Only
Analog In2	Indicates the percent of full scale measured by analog input 2	0 to 100.0	%	137	Read Only
SW Ver	Indicates the software version number (x.xx.x)	0 to 65535		48	Read Only
SW Rel	Indicates the software release date year and week (yyww)	0 to 65535		49	Read Only
Unit Type	Indicates the type of power controller			36	Read Only

Option	Description	Value
RC 1	Single Phase	7
RC 2	Two Leg, three phase	8
RC 3	Three Leg, three phase	9
RC 3P	Three Leg, three phase with phase angle capability	9999

Parameter Name	Description	Range	Unit	Modbus Address	Par. Type
Max Voltage	Indicates the maximum voltage rating of the power controller	0 to 1023	V	41	Read Only
Max Current	Indicates the maximum current capacity of the power controller	0 to 9999	A	62	Read Only
Aux Voltage	Indicates the measured line voltage	0 to 1023	V	43	Read Only
Serial No	Indicates the serial number of the power controller	0 to 9999		149-150 151-152	Read Only
SCR Temp	Indicates whether the SCR is below or above the factory-set trip point			127	Read Only

Option	Description	Value
Disabled	No sensor present / temperature below limit	0
Over Temp	Over temperature	130

10 Using the Configurator

Configurator software can be used like an alternative of the power controller's keypad and set the advanced features not available via the power controller's onboard user interface. Here we explain how to use it.

10.1 Typical Uses

The software may be used during commissioning to:

- set internal parameter do determine how the power controller operates and performs;
- save and restore a setup, copy or clone one power controller to another;
- on a day-to-day basis to monitor operation and power usage;
- examine performance in more detail to determine if any corrective actions are needed.

10.2 Communicating with Power Controllers

When commissioning the power controller, may be useful to connect a computer via the USB port, located below the control panel's display, so it's possible to configure and examine the settings of the controller. The controller's electronics is powered vis USB cable, so it's to possible to inspect it before applying power.

NOTE! the power of the USB port is limited and not designed to power industrial cards, so it manages to feed only the essential parts of the electronics. For complete control, you need to power up the auxiliaries of the power controller.

10.3 Recipes

A recipe is a file that store the settings of power controller's internal parameter. It is used to save a power controller configuration or to restore an existing configuration in a power controller.

10.3.1 Upload a recipe

A recipe is created using upload function in the Configurator software and saving it as a file on the computer.

10.3.2 Download a recipe

An existing recipe can be downloaded to a power controller using download function in Configurator software.

10.4 How To

Here the procedures for common tasks are described step-by-step.

10.4.1 Install and communication with the power controller

Procedure to install the Configurator:

- 1) Locate the installer
 direct link: https://www.cdautomation.com/wp-content/uploads/ThyristorConfigurator_ver6.zip
 On our website: "Download" page --> Software and communication or Product page --> SW/Comm tab
- 2) Double-click on the installer program to start installation.
- 3) Follow the on-screen instructions.

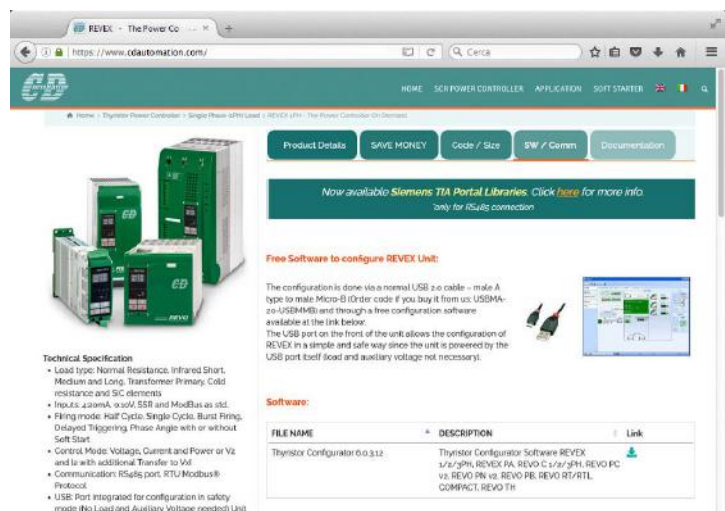

Procedure to communicate with a power controller:

- 1) **if used direct USB connection:**
 - Connect the USB cable between the computer and the micro USB connector on the power controller's keypad
 - if necessary, wait for the USB driver to install.

- 2) **if used RS-485 connection** connect the power controller terminal to computer RS485 port. Usually the standard pc do not have a RS485 port so a USB-to-485 converter is required.

- 3) Launch the Configurator software and select
 - **REVEX 1PH:** for single phase
 - **REVEX 2/3PH:** for 2 or 3 phase power controller

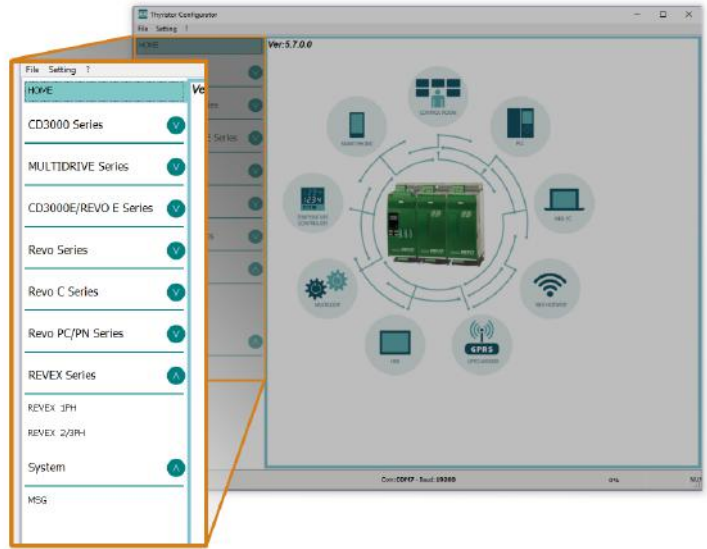

- 4) Choose **Serial Port** From **Setting -> Serial Port** menu
- 5) In value **Port**, select the COM port connected to the power controller (see the note below)
- 6) To verify communications, click **Test**
- 7) Click **OK**

NOTE! to determine which port is connected to the power controller, you can:

- in the Windows" Device Manager, under Ports (COM & LPT), looking for the COM port named "LPC USB VCOM Port (COMx)" where x is the port number
- On configurator software:
 - open the software without connect the unit and see the available COM port on COM port window setting,
 - close the COM setting window,
 - connect the USB cable to the power controller (wait for the USB driver to install if necessary),- open the COM setting window, see the added COM number and select it.

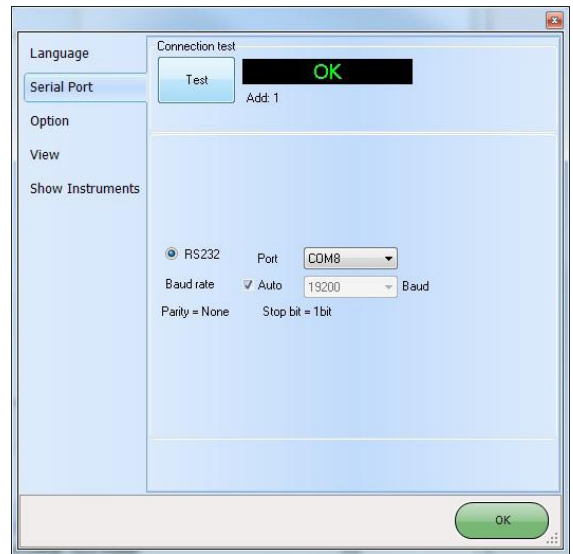

10.5 Using the Configurator

After the software has been installed, communication has been set up and model type selected, is possible to operate with the power controller.

10.5.1 To view or save a power controller's settings using "Simple" view section:

- 1) Click **Simple**, if not already on the simple view
- 2) Click **Upload from unit**
- 3) Set the address, if necessary
- 4) Click **READ->**
- 5) Wait for the software to read the parameter settings
- 6) Click **OK**
- 7) If necessary save the settings in a recipe file:
 - Click **Save**
 - Name the recipe
 - Click **Save** button

NOTE! In the simple view the change are not "live", so to take effect the change in simple section is necessary to download it following download procedure.

10.5.2 To edit a setting in a recipe:

- 1) Click **Simple**, if not already on the simple view
- 2) Click **Open** existing recipe
- 3) Locate and select the recipe file and click **Open**
- 4) Click **OK**
- 5) Click the menu with the setting you want to change
 - **SETUP**
 - **ADVANCED SETUP**
 - **HARDWARE**
 - **COMMUNICATIONS**
- 6) Select the value you want to change
- 7) Edit the value with the increment and decrement buttons in the field or type the new value and press the Enter key
- 8) Repeat steps 5 to 7 for all the changes you want to make
- 9) To save the settings in a recipe file:
 - Click **Save**
 - Name the recipe
 - Click **Save** button

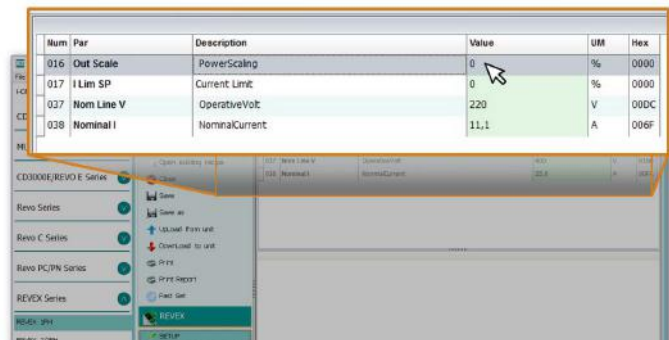
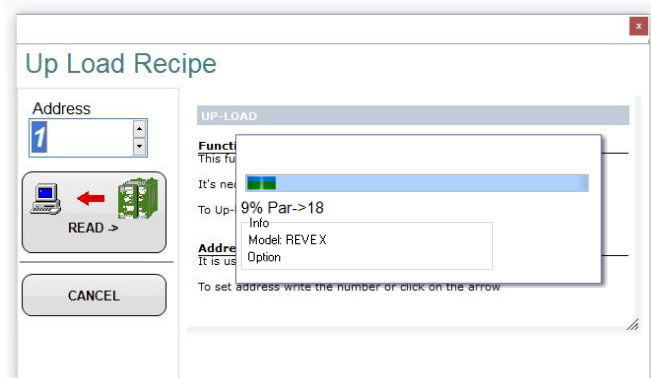
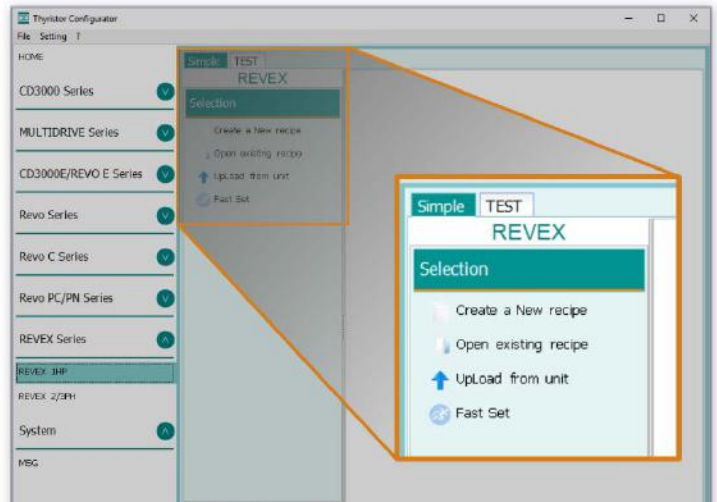

10.5.3 To download a recipe file into a power controller:

- 1) Click **Simple**, if not already on the Simple view
- 2) Click **Open** existing recipe
- 3) Locate and select the recipe file and click **Open**
- 4) Click **OK**
- 5) Click **Download to unit**
- 6) Set the address, if necessary
- 7) Click **SEND->**
- 8) Wait for the software to write the parameter settings
- 9) Click **OK**

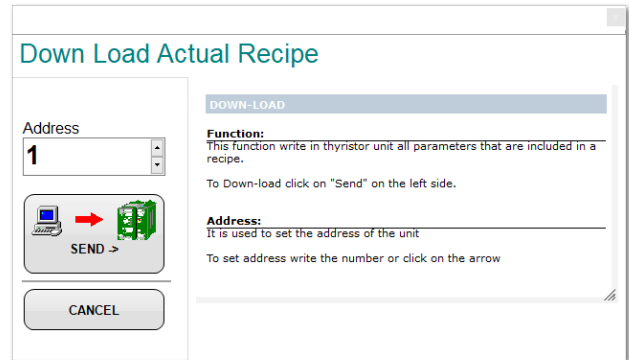

10.5.4 To monitor a power controller with the Test view:

- 1) Click **Test**, if not already on the test view
- 2) Click **Online**

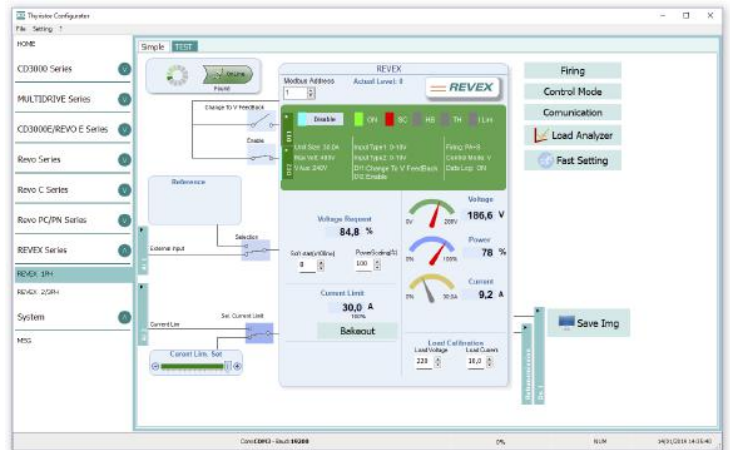

10.5.5 To log in on the test view to change the digital input and analog input functions:

- 1) Click the **Access Level** value (zero when logged out)
- 2) Type the password: **1111**
- 3) Click **OK**

10.5.6 To log out the test view:

- 1) Click the Access Level value.
- 2) Click **Log out**.
- 3) Click **OK**.

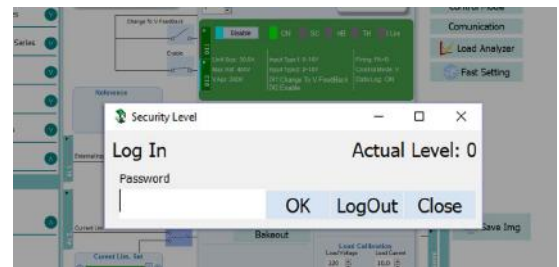

10.5.7 To view data on the scope:

- 1) Click **Test**, if not already on the test view
- 2) Click **Online**
- 3) Click **Load Analyzer**
- 4) For each of up to three channels (Ch 1 to Ch 3):
 - With **PV1** choose the value to monitor
 - Select **Show**
 - Click the color swatch to change the color
 - Click the button to turn the channel on.



10.6 Software General information

Here it is described the Configurator Software and how to use it.

10.6.1 Program Window

Main Menu

Access these menus.

File menu

Exit: close the program

Setting menu

Language: open Language Settings dialog box

Serial Port: open Serial Port dialog box

Option: open General Option dialog box

? (Help) menu

Message Log: open a serial communication message view

About: displays the About dialog with the program name and version and contact information

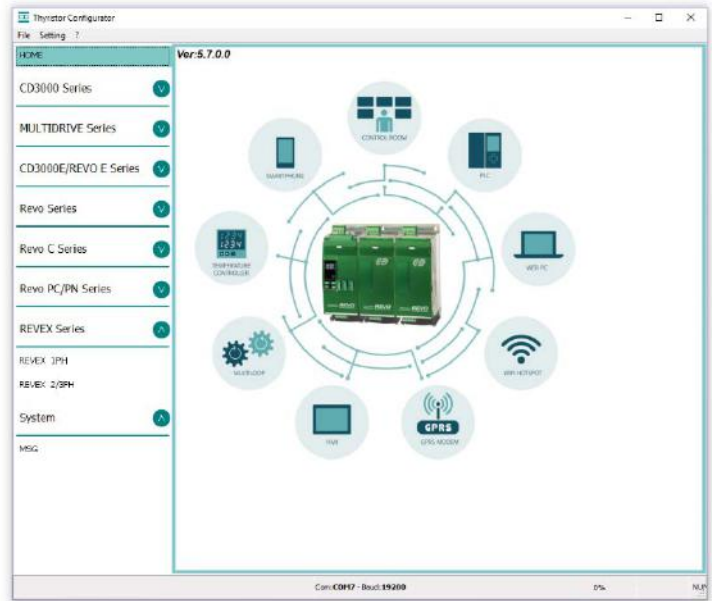

Instruments selector

Select the right instrument to use:

HOME: the default view

REVEX 1PH: open the Simple and Test views for a single-phase power controller

REVEX 2/3PH: access the Simple and Test views for a two-phase or three-phase power controller

MSG: opens a serial communication message view

Status Bar

Indicates information such as time and date, communications port and baud rate.

10.6.2 Simple Section

This section is used to create, save, upload and download recipes of parameters settings. Can be used also to see the settings in a controller.

Simple page is the default page when select the model using the Model Button, but if not selected is possible to access it by clicking the Simple tab below the main menu.

NOTE! This section is not "OnLine" so the parameter values are not updated continuously. They are read only when you upload them from the power controller.

To manage a recipe click on:

Create a New recipe: create a recipe file with the standard default settings

Open existing recipe: open an existing recipe file

Upload from unit: create a new recipe with the value uploaded from a connected power controller

Close: close the current recipe

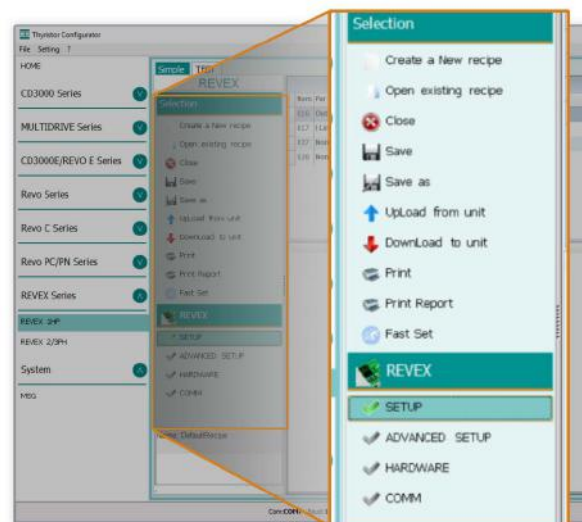

Save: save the recipe in a file

Save as: save a copy of the recipe in a file

Download to unit: send the current recipe parameters in the connected power controller

Print: print the recipe (see sample at right)

Print report: print the recipe (see sample at right)

REVEX Recipe 10010010143411

Par	Description	Desc	Val
SETUP			
P010	OutScale	PowerScaling	0%
P011	I Lim SP	Current Limit	0
P020	NomLineV	OperativeVolt	220V
P030	NominalI	NominalCurrent	11.1A
ADVANCED SETUP			
P100	EnableFiring	Firing	OFF: StopFiring
P110	EnableControlMode	Control Mode	VS
P120	EnableStartFiring	Start Firing	0
P130	EnableStartFiring	Start Firing	0
P140	EnableStartFiring	Start Firing	0
P150	EnableStartFiring	Start Firing	0
P160	EnableStartFiring	Start Firing	0
P170	EnableStartFiring	Start Firing	0
P180	EnableStartFiring	Start Firing	0
P190	EnableStartFiring	Start Firing	0
P200	EnableStartFiring	Start Firing	0
P210	EnableStartFiring	Start Firing	0
P220	EnableStartFiring	Start Firing	0
P230	EnableStartFiring	Start Firing	0
P240	EnableStartFiring	Start Firing	0
P250	EnableStartFiring	Start Firing	0
P260	EnableStartFiring	Start Firing	0
P270	EnableStartFiring	Start Firing	0
P280	EnableStartFiring	Start Firing	0
P290	EnableStartFiring	Start Firing	0
P300	EnableStartFiring	Start Firing	0
P310	EnableStartFiring	Start Firing	0
P320	EnableStartFiring	Start Firing	0
P330	EnableStartFiring	Start Firing	0
P340	EnableStartFiring	Start Firing	0
P350	EnableStartFiring	Start Firing	0
P360	EnableStartFiring	Start Firing	0
P370	EnableStartFiring	Start Firing	0
P380	EnableStartFiring	Start Firing	0
P390	EnableStartFiring	Start Firing	0
P400	EnableStartFiring	Start Firing	0
HARDWARE			
P410	EnableStartFiring	Start Firing	0
P420	EnableStartFiring	Start Firing	0
P430	EnableStartFiring	Start Firing	0
P440	EnableStartFiring	Start Firing	0
P450	EnableStartFiring	Start Firing	0
P460	EnableStartFiring	Start Firing	0
P470	EnableStartFiring	Start Firing	0
P480	EnableStartFiring	Start Firing	0
P490	EnableStartFiring	Start Firing	0
P500	EnableStartFiring	Start Firing	0
P510	EnableStartFiring	Start Firing	0
P520	EnableStartFiring	Start Firing	0
P530	EnableStartFiring	Start Firing	0
P540	EnableStartFiring	Start Firing	0
P550	EnableStartFiring	Start Firing	0
P560	EnableStartFiring	Start Firing	0
P570	EnableStartFiring	Start Firing	0
P580	EnableStartFiring	Start Firing	0
P590	EnableStartFiring	Start Firing	0
P600	EnableStartFiring	Start Firing	0
P610	EnableStartFiring	Start Firing	0
P620	EnableStartFiring	Start Firing	0
P630	EnableStartFiring	Start Firing	0
P640	EnableStartFiring	Start Firing	0
P650	EnableStartFiring	Start Firing	0
P660	EnableStartFiring	Start Firing	0
P670	EnableStartFiring	Start Firing	0
P680	EnableStartFiring	Start Firing	0
P690	EnableStartFiring	Start Firing	0
P700	EnableStartFiring	Start Firing	0
P710	EnableStartFiring	Start Firing	0
P720	EnableStartFiring	Start Firing	0
P730	EnableStartFiring	Start Firing	0
P740	EnableStartFiring	Start Firing	0
P750	EnableStartFiring	Start Firing	0
P760	EnableStartFiring	Start Firing	0
P770	EnableStartFiring	Start Firing	0
P780	EnableStartFiring	Start Firing	0
P790	EnableStartFiring	Start Firing	0
P800	EnableStartFiring	Start Firing	0
P810	EnableStartFiring	Start Firing	0
P820	EnableStartFiring	Start Firing	0
P830	EnableStartFiring	Start Firing	0
P840	EnableStartFiring	Start Firing	0
P850	EnableStartFiring	Start Firing	0
P860	EnableStartFiring	Start Firing	0
P870	EnableStartFiring	Start Firing	0
P880	EnableStartFiring	Start Firing	0
P890	EnableStartFiring	Start Firing	0
P900	EnableStartFiring	Start Firing	0
COMM			
P910	EnableStartFiring	Start Firing	0
P920	EnableStartFiring	Start Firing	0
P930	EnableStartFiring	Start Firing	0
P940	EnableStartFiring	Start Firing	0
P950	EnableStartFiring	Start Firing	0
P960	EnableStartFiring	Start Firing	0
P970	EnableStartFiring	Start Firing	0
P980	EnableStartFiring	Start Firing	0
P990	EnableStartFiring	Start Firing	0

To edit the actual recipe values click a parameter menu name:

SETUP

ADVANCED SETUP

HARDWARE

COMMUNICATIONS

and after click on the value and modify it.

Num	Par	Description	Value	UM	Hex
016	Out Scale	PowerScaling	0	%	0000
017	I Lim SP	Current Limit	0	%	0000
037	Nom Line V	OperativeVolt	220	V	00DC
038	Nominal I	NominalCurrent	11,1	A	006F

Left sidebar menu: REVEX 1PH, REVEX 20PH, System, MSC.

NOTE! Changes to the values here affect the open recipe only. To apply these changes to the power controller settings, download them to the power controller using the Download to unit option.



10.6.3 Test Section

This section is used to monitor and adjust the operation of the power controller in real time using RS485 or USB communication port. After select the model, is possible access to this section clicking the "TEST" tab below the main menu.

Operating on TEST Section:

Online button: is the button to start or stop communication updates with the power controller.

After communication starts, a green communication status indicator spins clockwise when the software communicates correctly with a power controller, if the connection link is broken the color will become red

Address: value used to set the power controller address

Access Level: click the value to log in or out. Default Password address is "1111".

REVEX TEST interface showing: Voltage (186.6 V), Power (78 %), Current Limit (30.0 A), and various control buttons like Firing, Control Mode, Communication, Load Analyzer, Fast Setting, and Save Img.

To configure and monitor the digital inputs:

Digital input states and functions:

show whether each input detects an open or closed circuit and the function the input performs.

Digital Input States and Function Selectors:

set the function for each digital input. Click DI1 or DI2 to expand the options.

Status and Setup Indicators:

Digital input status: light on when the input is a closed circuit

Enable indicator: light on when the power controller is enabled

Enable/Disable button: click on to enable the power controller if a digital input is not configured for this function

ON indicator: light on when there is demand for the output to be on

SC indicator: light on when there is a shorted SCR alarm active

HB indicator: light on when there is a heater break alarm active

TH indicator: light on when the heat sink over temperature alarm is active

I Lim indicator: light on when the load current exceeds the current limit setting

Unit Size: indicate the maximum rated current of the power controller

Max Volt: indicate the maximum rated voltage for the power controller

V Aux: indicate the voltage the auxiliary input is set to use for powering the electronics

Input Type1: indicate the signal analog input 1's type

Input Type2: indicate the signal analog input 2's type

DI1: indicate digital input 1's function

DI2: indicate digital input 2's function

Firing: indicate the firing type the power controller is set to use

Feedback: indicate the feedback type the power controller is set to use

Data Log: indicate the Data Log status.

Buttons setup options:

Firing: view and set the firing type and the associated parameters

Feedback: view and set feedback type

Communication: view and set communication options for ports, protocols and fieldbus

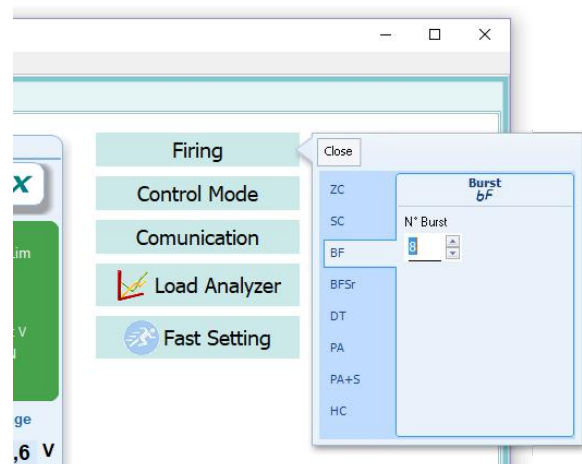
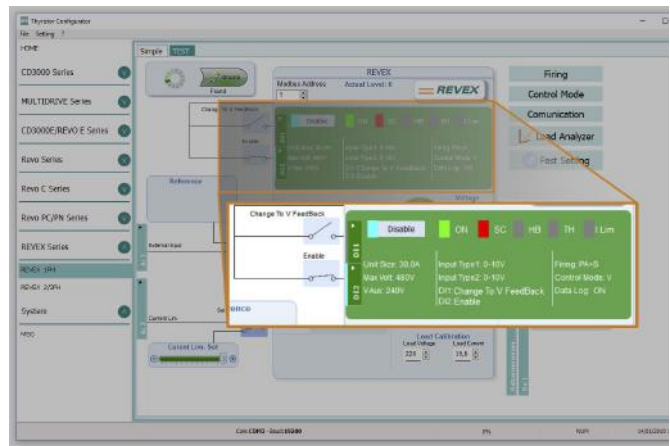

Configure and monitor the analog inputs:

Analog Input 1: click Ai 1 to view the signal type

Input Local/Remote selection button: click to toggle between using the signal received at analog input 1 (remote) or the slider (local) to set the set point.

Reference: drag the slider, click the increment (+) or decrement (-) buttons or click one of the three percentages (0%, 50% or 100%) to set the set point when the set point source is set to local.

Analog Input 2: click Ai 2 to view the signal type and function

To configure and monitor the power controller:

Power Request: show the set point signal from analog input 1.

The value is a percent of full scale or can be set with the reference slider

Soft Start Time: show the time over which set point changes are ramped

Output Scaling: show the scaling applied to the set point signal before it is used by the control loop

Voltage indicator: show the RMS load voltage

Power indicator: show the RMS load power

Current indicator: show the RMS load current

Current Limit Set: indicates the current limit set point

Bakeout button: click to view and set the heater bakeout feature options

Load Calibration: set and view the nominal line voltage and nominal load current settings for the application.



NOTE! The Load Calibration settings, Load Voltage and Load Current define 100% power for the load.

10.6.4. Load Analyzer

Load Analyzer is used for monitoring values graphically represented

Click on **Load Analyzer** button on the test page to open Load Analyzer window.

It's possible to see 3 channels (Ch 1, Ch 2 and Ch 3).

For each channel configure a pen on the graph:

On/Off button: click to start trending data reading

PV: choose the parameter to trend

Show: set this option to display or hide the trend

Show Mark: set this option to display data markers along the trend in the graph area

Live!: click to view the current waveform on a graph.

Data Log: click to open the Data Log window.

The **History** options to control the movement of the chart:

Scroll left-click: move the chart left to view more recent data

Stop/Play-click: toggle the live view or Hystorical view of graphic signal

Scroll right-click: move the chart right to view older data

The **Actions** to:

Clear: to clear the data from the graph

Save: to save a JPEG image of the **Load Analyzer** window with the current trends

Export: to open a window that includes the trend graph and table with the currently displayed data that can be saved as a JPEG or exported to a CSV file.

Use the **X - Scale** settings to adjust the horizontal (time) axis:

Min: set the minutes of data displayed

Sec: set the seconds of data displayed

Filter: set this option to filter the data

Use the **Y - Scale** settings to adjust the vertical (percent of full scale) axis

Max: set the maximum value for the vertical axis

Reset: click to reset the vertical axis scaling



NOTE! Use the increment (up arrow) and decrement (down arrow) buttons to adjust the x and y scales. Numeric entry does not allow the full range of values to be set.



10.6.5 Live! Scope

This view provides a graph of current waveform over a few sample cycles. Data will be automatically updated when Enable will be selected.

Use these options to configure the displayed data:

Enable: set this option to view the current on the graph

Save: click to save a JPEG image of current window

Show Data: click to open the Data panel on the right of the graph that shows the data points for the current sample

Auto Scale: select this option so that the Configurator automatically adjusts the X and Y axis settings.

Y Axis:

Max: show or set the high end of the vertical axis

Min: show or set the low end of the vertical axis

Marks: set this option to display data markers along the trend in the graph area.

X Axis (future use):

Max: show actually high end of the horizontal axis

Min: show actually low end of the horizontal axis

Reset X: Reset the high end and low end of of the horizontal axis to initial value after a zoom action.

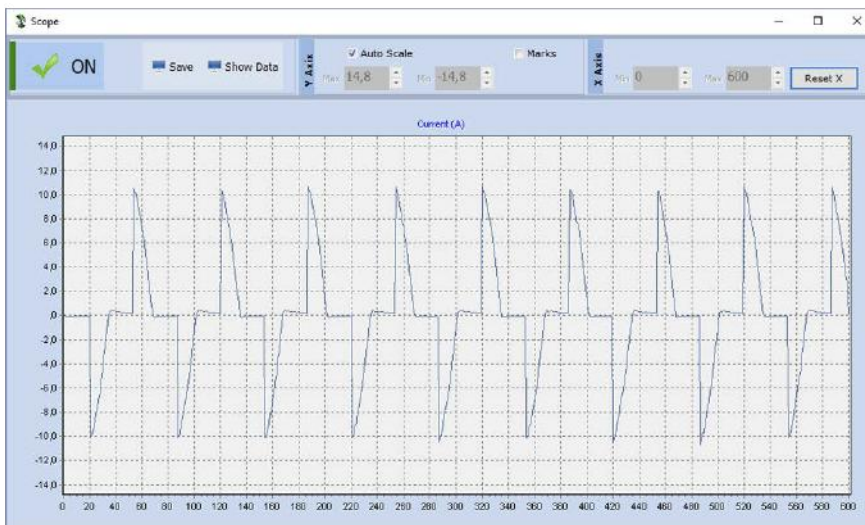

10.6.6 MSG view

Message view shows the communication activity between the computer and the power controller.

PORT

COM: use this view to see when the COM port is accessed and its settings

MODBUS: Modbus communication protocol area

READ Area: use this view to see parameters being polled

READ Area -> En Log: enable a short read communication log activity

READ Area -> En Detail: if En Log enabled enable a detailed read communication log activity

READ Area -> Only Error: if En Log enabled enable a read communication log activity only if in error

WRITE Area: use this view to see which parameters and values are sent to the power control

READ Area -> En Log: enable a write communication log activity

Log Msg: use this view to see the "Data Log" protocol detail when Data Log window is active

Status: view the status and settings of the COM port

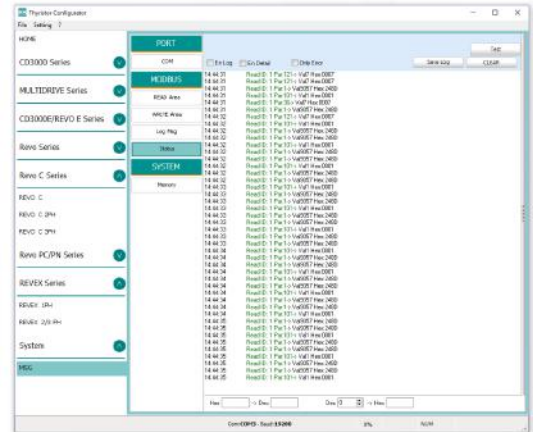

SYSTEM

Memory: view the memory usage of the Configurator software on the computer

10.6.7 Settings window

Use this window to choose user-settable options for the Configurator software.

Language:

Available Languages: choose the language used in the software

NOTE! to activate the language change, you need to close and open again the Configurator software

Serial Port:

Test: click to test for communication with a power controller via the selected port

Port: select the computer's COM port to use to communicate with power controllers

Baud rate: select Auto to allow the Configurator to set the baud rate for the COM port or deselect the option to manually set the baud rate.

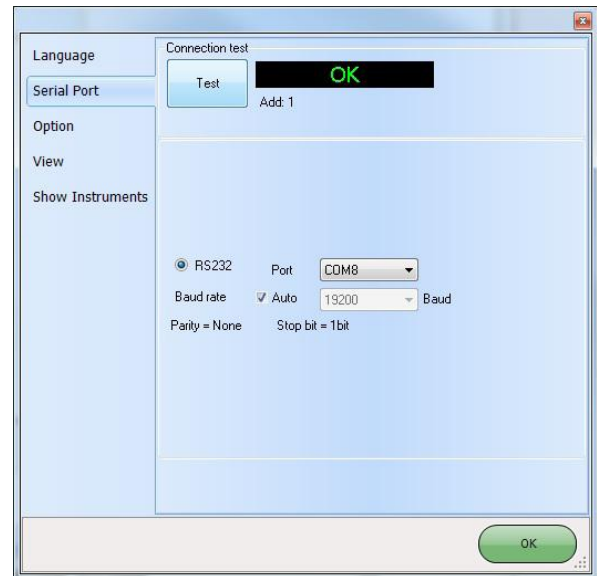

Options:

List Options: set whether or not parameter values are displayed in hexadecimal in simple view recipes

Directory: set the directories in which recipes and images are saved

Disable Check Type: set to allow communication with power controllers that are not precise matches for the supported types. Used only for special version. Note that set is not memorized after software shutdown

View:

Hide Tool Bar: future use

Hide Status Bar: select to hide the status bar that appears at the bottom of the program window

Show Instruments: Hide or show the available instrument in the left side of main windows

11

Configurable Inputs and Outputs

The REVEX power controller features two digital inputs, up to two analog inputs and a relay output. Some models also include an analog output for retransmitting a measured value to other automation equipment. This section describes the various functions of these inputs and outputs and how they interact with other features of the power controller.

11.1 Digital Inputs

The REVEX power controller has two optically-isolated, digital inputs that can be connected to control panel switches or other automation equipment such as a temperature controller or programmable logic controller. Using Digital In 1 Function and Digital In 2 Function on the hardware menu each digital input can be configured to perform one of the following:

- **Enable:** the power output is off unless this signal is on. If both digital inputs are set to this option, the state of digital input 2 takes precedence (DI2 Default Configuration).
- **Voltage Feedback:** this signal overrides the feedback setting. When this signal is on, the control loop uses voltage feedback. When the signal is off, the loop reverts to the feedback parameter setting (DI1 default Configuration).
- **Local / Remote:** this signal selects how the set point is set. When this signal is on, the control loop's set point is set using the keypad or through communications. When this signal is off, the set point is set by the an analog input. When a digital input is set to this function, the Local/Remote (L/R) button on the front panel cannot be used to choose the source of the set point.
- **Phase Angle:** this signal overrides the Firing setting. When this signal is on, the power controller uses phase-angle firing. When the signal is off, the controller uses the method set with the firing parameter on the advanced setup menu.
- **SP Analog In 1 / 2:** this signal chooses which of the two analog inputs is used as the source of the set point when the remote set point is in effect. When this signal is off, analog input 1 is the source of the remote set point. When the signal is on, analog input 2 is the source of the remote set point.
- **Logging:** this signal turns data logging on or off. When the signal is on, data is logged. When the signal is off, data is not logged. When this signal is on, it supersedes the setting of the Logging parameter on the advanced setup menu.
- **Heater Bakeout:** this signal turns the heater bakeout feature on or off. When the signal is on, the heater bakeout feature is enabled. When the signal is off, the heater bakeout feature is disabled. When this signal is on, it supersedes the setting of the Heater Bakeout parameter on the advanced setup menu.
- **Fast Enable (SSR Input):** configuration used for SSR input (see figure in paragraph 8.2.1). This input configuration allows controlling the unit with a logic signal (ON / OFF) with voltage $4 \div 30\text{Vdc}$ 5mA Max (ON $\geq 4\text{Vdc}$ OFF $< 1\text{Vdc}$) - 3HZ Max on time min. 100 ms. When the Fast Enable input is enabled, Phase Angle firing is automatically selected.
- **Alarm Reset:** reset the Alarm relay Output if an alarm/s triggered. When this function is selected, and the digital input is on, the HB alarm resets. If the Digital Input is off and the problem persist, the alarm is reactivated.

To configure how the power controller uses these signals, see "Digital In 1 Function" and "Digital In 2 Function" on Paragraph **9.4.4 Hardware menu**.

11.2 Analog Input 1: Set Point

To control the power to the load with a device such as a temperature controller, connect the control signal to analog input 1.

This input accepts current, voltage and potentiometer signals. The signal is interpreted as set point by comparing the measured value to the input's full scale. For example, the set point is 50% when the analog input detects 5V and the input is configured to receive 0 to 10Vdc.

Configure the power controller to recognize the signal with the hardware menu; see "Analog In 1" on Paragraph **9.4.4 Hardware menu**. For instructions for wiring see paragraph 8.2 Schematic.

11.3 Analog Input 2: Set Point, Feedback or Current Limit Set Point

What this input does is user-configurable. Connect an analog signal that indicates:

- An alternate set point signal
- Measured power, voltage or current from an external device used as feedback
- Maximum current to the load (current limit).

This input accepts current, voltage and potentiometer signals. The signal is interpreted by comparing its measured value to the input's full scale. For example, the signal is 50% when the analog input detects 12mADC and the input is configured to receive 4 to 20mADC.

Configure the power controller to recognize the signal and how the power controller uses it on the hardware menu; see "Analog In 2" on Paragraph **9.4.4 Hardware menu**. For instructions for wiring see paragraph 8.2 Schematic.

11.4 Alarms and Alarm Relay Output

When an alarm occurs and while the condition persists, the alarm relay is de-energized. The alarm relay is energized when power is supplied to the controller's electronics via the auxiliary power input and there are no alarms.

Choose which conditions determine the alarm relay output with the Alarm Function setting on Paragraph **9.4.4 Hardware menu**.

Alarm Function Options

	Alarm Output Energizes for...				
	Heater Break	Shorted SCR	Current Limit	Communication Watchdog Error	Heat Sink Over Temperature
None					X
Heater Break (HB)	X				X
SCR Short (SC)		X			X
I Limit (IL)			X		
HB / SC	X	X			X
HB / IL	X		X		
SC / IL		X	X		
HB / SC / IL	X	X	X		
Watchdog (WD)				X	X
WD / HB	X			X	X
WD / SC		X		X	X
WD / SC / HB	X	X		X	X
WD / IL			X		
WD / IL / HB	X		X	X	X
WD / IL or SC		X	X		
WD / IL or SC / HB	X	X	X	X	X



NOTE! The alarm relay output indicates an alarm whenever the temperature of the heat sink is too high even when Alarm Function on the hardware menu is set to None.



NOTE! The power controller monitors for heater break or short circuit conditions only when included in the option selected for Alarm Function.

12 Alarm description

12.1 Heater Break Alarm

This option allows you to diagnose any load breakage. The diagnostics is based on the comparison of the value of the nominal resistance of the load with respect to the resistance measured in real time. The nominal resistance is calculated using the **Operative Load Voltage (Nom Line V)** and **Nominal Current of the load (Nominal I)** parameters.

Nominal Resistance $R = \text{Nom Line V} / \text{Nominal I}$

The alarm threshold value is the value of the nominal resistance increased by the percentage defined by the HB Sense parameter

Example:

Resistance 2200W @ 220V

power/voltage= A --> 2200/220 = 10A

- nominal V: 220 V
- nominal I: 10A
- Nominal resistance - $R = 22 \text{ Ohm}$

HB sense parameter = 20% --> threshold value = $22 + (22 \times 20 / 100) = 22 + 4,4 \text{ Ohm} = 26,4 \text{ Ohm}$

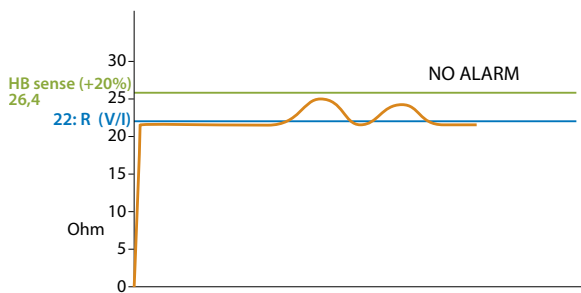

The alarm activates when the detected Runtime resistance exceeds the value of 26.4 Ohm.

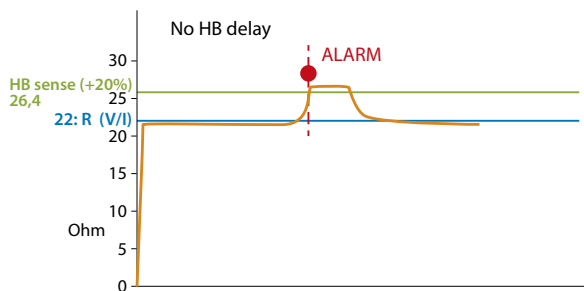

Using the HB Delay parameter, the alarm intervention can be delayed.

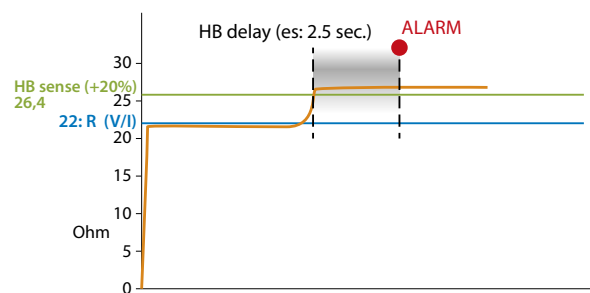
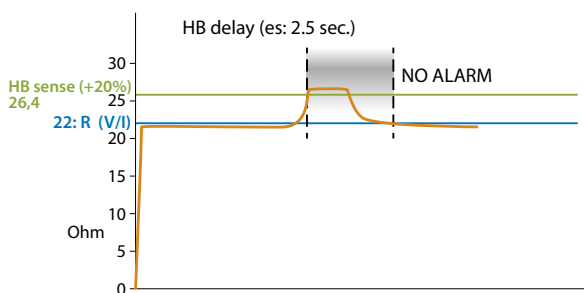

Sensitivity (HB sense) and delay (HB delay) can be varied according to the application (see parameters on pages 33-34).

12.2 AUX High

This alarm is displayed when the auxiliary supply voltage exceeds the established ranges. If the alarm situation persists for more than 5 seconds, the unit will go into protection.

12.3 AUX Low

This alarm is displayed when the auxiliary supply voltage is lower than the established ranges. This alarm condition could lead to incorrect unit operation.

12.4 ComError

If the communication watchdog function is enabled (watchdog ON) this alarm is activated when there is no data passage within the time established by the "WD reset" parameter.

12.5 AUX Line Loss

This alarm is activated when there is no auxiliary voltage.

12.6 Line Loss

This alarm is activated when L1 and L2 are not detected.

12.7 I Limit

This alarm is activated when the operating current exceeds the current limit value set in the I Limit SP parameter.

12.8 SHRT

This alarm is activated if the unit detects a short circuit in one of the power devices. This alarm could also activate when the current measured by the unit is greater than 80% of the value set in Nominal I.

12.9 SCR Temp

This alarm is activated when the heat sink temperature exceeds the set threshold value (80°C).

13 "Enable" Function in static Unit

The "Enable" function can work in several ways

- from Digital input
- from Serial Port
- from Digital Input + Serial Port
- from FieldBus
- from Digital Input + FieldBus

To simplify in the various diagrams, the "enable" command from serial port will be represented by a "Software contact" abbreviated as Sw_S , and the command from digital input is abbreviated as Sw_H .

13.1 Using Digital Input only

By setting the Digital Input as "Enable" it is possible to control the enable from Digital Input.

By closing the digital input via Sw_H contact, the unit will be enabled and by opening the digital input the unit will be disabled.

The status can be read on bit 2 of parameter 14 on the serial port.

If bit 2 = 1: Enabled

If bit 2 = 0: Disabled

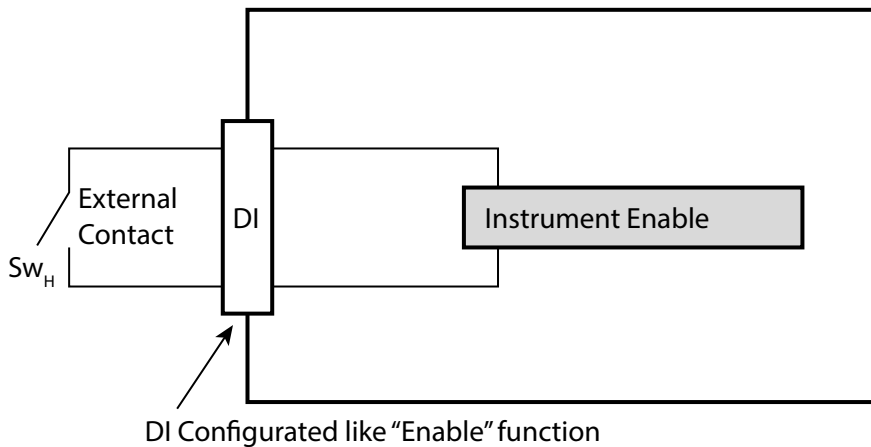

Sw_H = Switch hardware

13.2 Using Serial Port RS485 only

The static unit has an RS485 Modbus RTU serial port always present. By setting the Digital Input as "Not Used" or different from "Enable" it is possible to control the enable from serial port with bit 2 of parameter 14
 If bit 2 = 1: Enabled
 If bit 2 = 0: Disabled

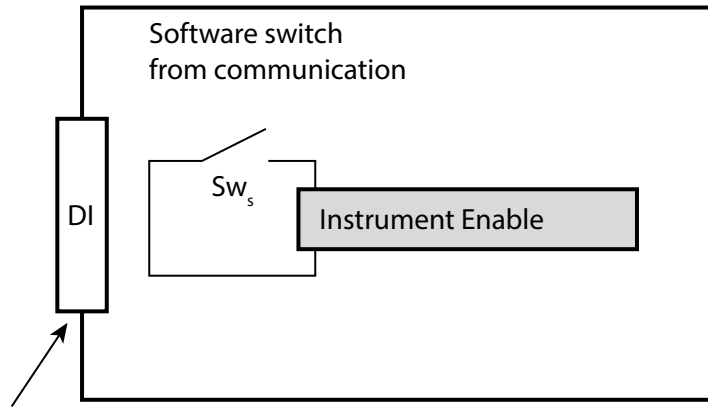

DI Function Configured like "Not Used" or different from "Enable"

Sw_s = Switch software

13.3 Using Digital Input + Serial Port RS485

The static unit has the serial port as standard RS485 Modbus RTU always present. The external contact Sw_H and the internal software contact Sw_s are connected in series, therefore if you want to enable the static unit, both contacts must be enabled. Each variation of the Sw_H contact connected on the digital Input (DI) is shown on the internal Sw_s contact, allowing correct operation. Using the serial port it is possible to change the status of the Sw_s contact with bit 2 of parameter 14, bearing in mind that it will be overwritten when the digital input is subsequently changed. This configuration is useful for having an external contact for a safety or emergency alternative to the serial command.

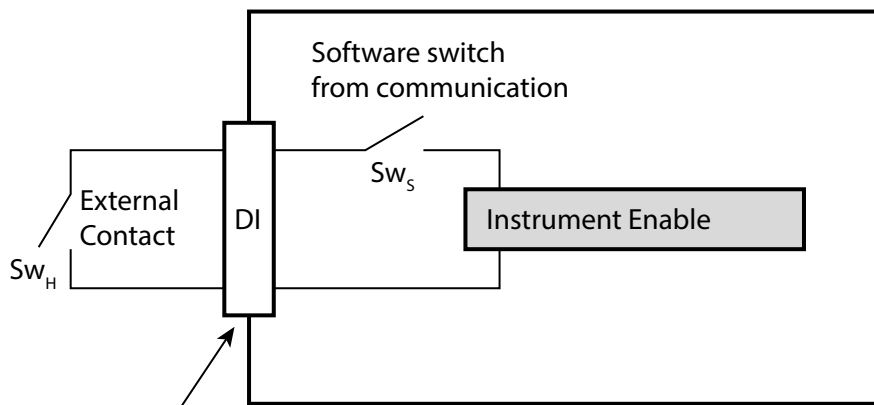

DI Configured like "Enable" function

Sw_H = Switch hardware

Sw_s = Switch software

13.4 Using FieldBus only

The static unit as an option can be ordered with a FieldBus (Ex: profinet). This option continuously writes the values on the unit keeping them up to date. Using the field bus it is possible to change the status of the Sw_s contact with bit 2 of the "Command table" (See the communication manual of the respective FieldBus).

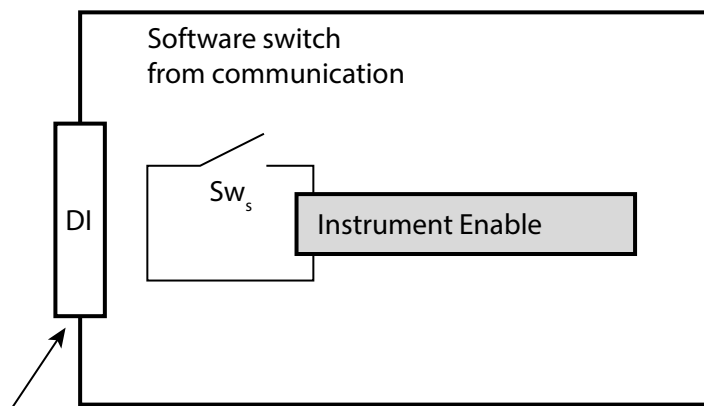

DI Function Configured like "Not Used" or different from "Enable"

Sw_s = Switch software

NOTE:

The parameters written are:

- command table
- reference
- rescaling

if the FieldBus is active but disconnected these values will be forced to 0.

13.5 Using Digital Input + FieldBus

The static unit as an option can be ordered with a FieldBus (Ex: profinet).

This option continuously writes the values on the unit keeping them up to date.

The external contact Sw_H and the internal software contact Sw_S are connected in series, therefore if you want to enable the static unit, both contacts must be enabled.

Using the FieldBus it is possible to change the status of the Sw_S contact with bit 2 of the "Command table" (See the communication manual of the respective FieldBus), bearing in mind that the Sw_H contact must also be closed to enable it.

This configuration is useful for having an external contact for a safety or emergency alternative to the FieldBus.

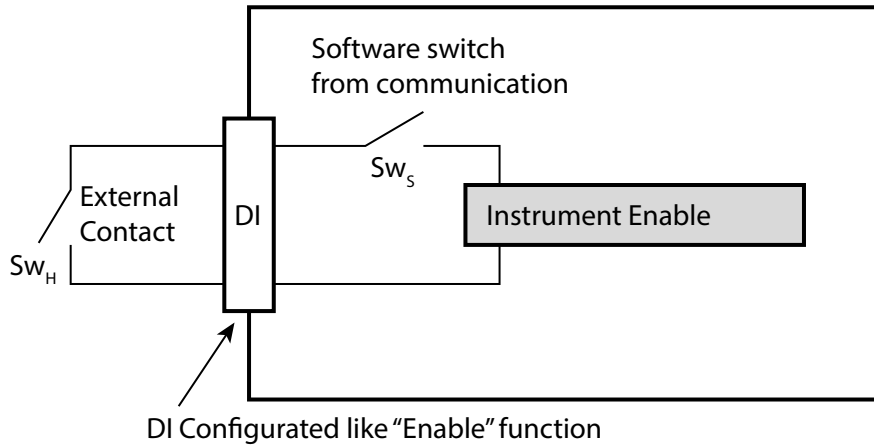

Sw_H = Switch hardware

Sw_S = Switch software

NOTE:

The parameters written are:

- command table
- reference
- rescaling

if the FieldBus is active but disconnected these values will be forced to 0.

14 Firing type

Choose a correct firing type allows to optimize the thyristor unit for the installed load. The firing type has already configured in line with customer requirements that are defined in the Order Code. The Order Code is written on the identification label. However, if you wish to change the firing type you can use the software configurator or the Control Panel.



Caution: this procedure must be performed only by qualified persons.

14.1 Zero Crossing

ZC firing mode is used with Logic Output from temperature controllers and the Thyristor operates like a contactor. The Cycle time is performed by temperature controller. ZC minimizes interferences because the Thyristor unit switches ON-OFF at zero voltage.

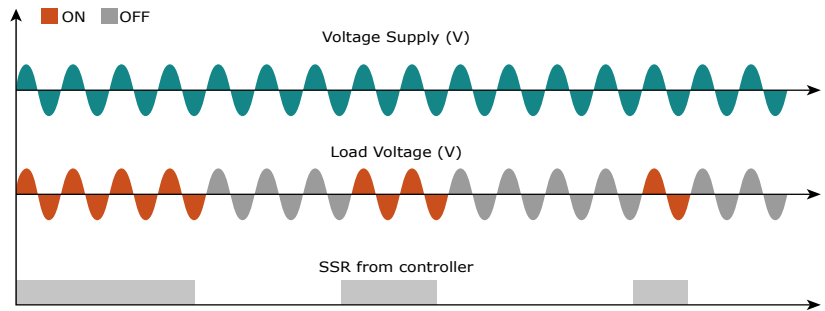

14.2 Single Cycle

Single Cycle it's the faster zero crossing switching method in relationship of the power demand from a temperature regulator or from an external signal. With input signal at 25% the output is one cycle ON and three cycles OFF. With input signal at 50% the output is one cycle ON and one cycle OFF. With input signal at 75% the output is three cycles ON and one cycle OFF. With input signal at 76% the output is the same of 75% but for each ON cycle the microprocessor divides 76/75, and when the sum of rests is one, the unit does one more cycle ON. For this firing is necessary to have analog input. The Single Cycle is used to control the loads with low inertia or for infrared lamps to short wave.

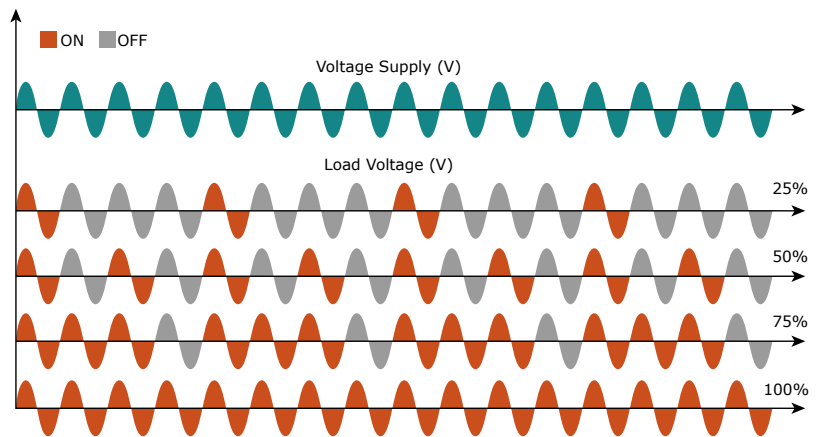

14.3 Burst Firing

The Burst Firing is similar to the Single Cycle, but consecutive cycles ON are selectable between 1 and 255, with input signal equal at 50%. When is specified 1 the firing type is Single Cycle. Burst Firing is a method zero crossing that it reduces the electromagnetic interferences because the thyristor switches at zero voltage crossing. The example show the Burst Firing with Burst cycles=4.

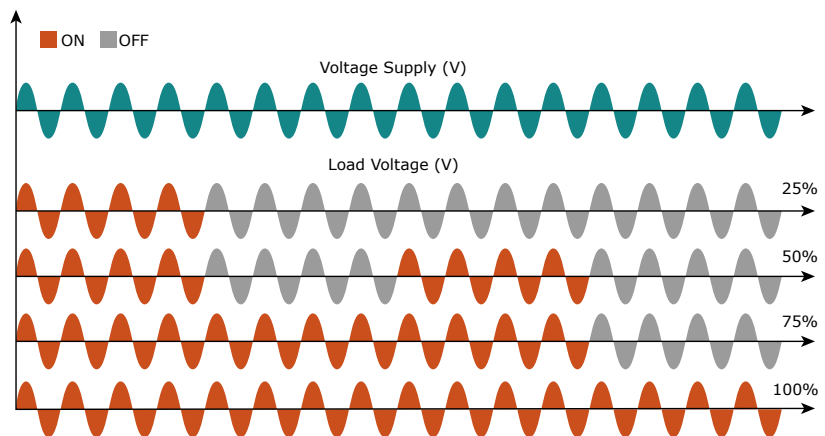

14.4 Soft Start with Burst Firing

This is an additional function to the Burst Firing. The unit start in phase angle mode with a ramp starting from zero up to the full tension in the cycles number set in the parameter.

When the ramp is over, the thyristor unit will stay in conduction at full voltage up to the end of cycles of burst. The S+BF firing is used to control small inductive loads to avoid inrush surge current and to reduce the electromagnetic interferences.

The example show the firing with Burst cycles =4 and start ramp half cycles=3.

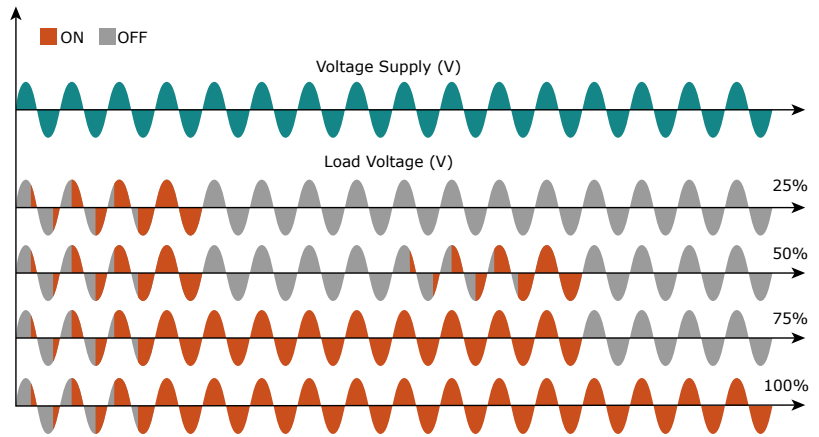

14.5 Phase Angle

The Phase Angle firing allow the control of the power on the load, for this firing the thyristor can be in conduction only for a part of the voltage cycle.

This part of the voltage cycle is adjustable in function of the input signal from 0 at 100%.

The PA firing is normally used for control the inductive loads, and is also possible control a primary of transformer coupled with the cold resistances like: Superkanthal, Molybdenum, Platinum, Tungsten or Quartz Lamp. The only disadvantage with phase angle is the possible generation of interferences that however can be reduced with oportune filters.

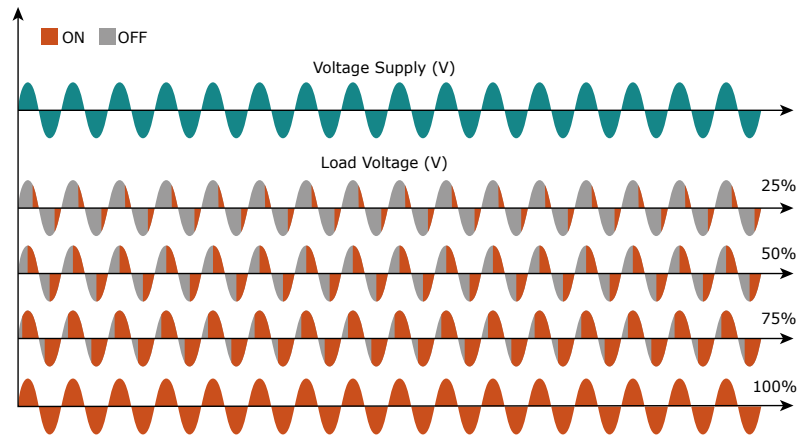

14.6 Soft Start with Phase Angle

This is an additional function to the Phase Angle. The firing angle of the thyristor increase or decrease up to the final setpoint value.

The Soft start ramp is an important feature to reduce the inrush current with transformers during the cycle of magnetization or with cold resistance that are near to the short circuit when they are supplied.

Setpoint Ramp Up / Setpoint Ramp Down.

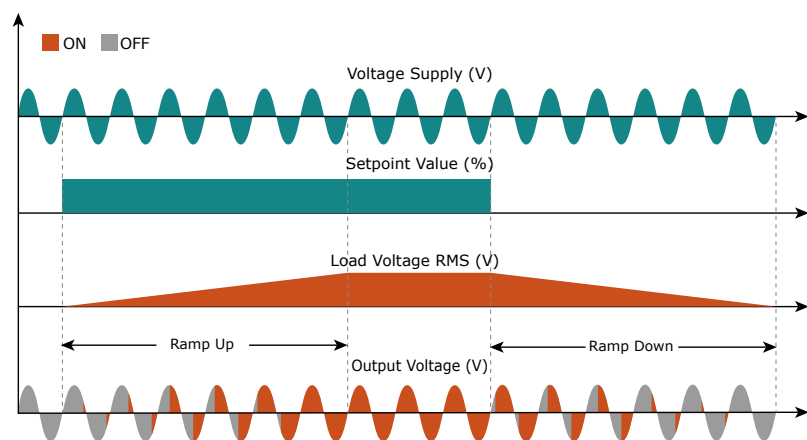

14.7 Delay Triggering with Burst Firing

The Delay Triggering firing is used to control a primary of transformer coupled with the normal resistances on the secondary (N.B. don't connect cold resistances on the secondary like: Superkanthal, Molybdenum, Platinum, Tungsten, Quartz Lamp).

For an inductive load (ex transformer), switching the thyristors at zero crossing can generate transient over currents that can blow the fuses, to avoid this problem you must use the Delay Triggering. This firing delay the first half cycle of Burst for an angle from 0 to 100° relative to the zero.

For understand the Delay Triggering firing, we have represented the waves generate by vectors that rotates in counterclockwise:

Without Delay Triggering

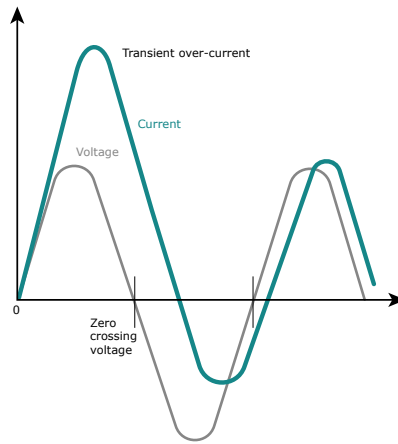

With Delay Triggering

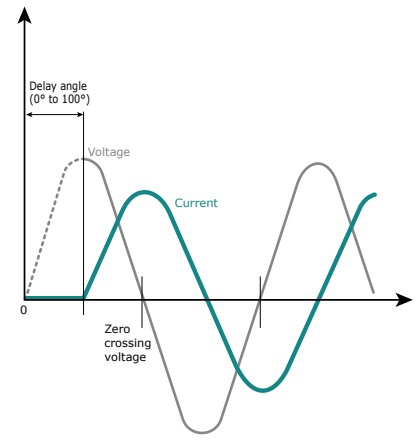

Without Delay Triggering

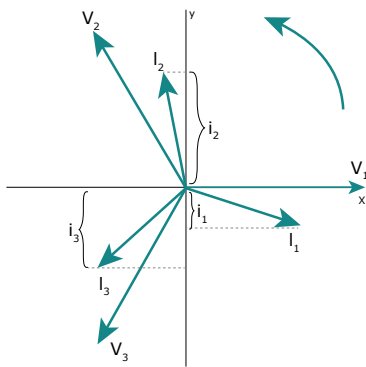

With Delay Triggering

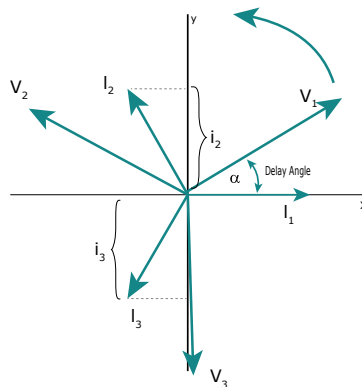

Without delay at zero crossing when V1 is to zero (projected on the X axis) the unit switch On.

In this case the instantaneous value of the currents are i1, i2 and i3 and this condition, for the curve of magnetization, could generate transient over currents that can blow the fuses.

With Delay Triggering the firing of the thyristor are triggered with a delay until the instantaneous value of the current i1=0, i2 positive and i3 negative like represented.

In this case the risk of transient

over currents is reduced and the fuses don't blow.

The angle alpha is the delay to have i1=0 and this angle depends on the power factor.

The delay angle suggest for most applications is 80°.

14.8 Half Cycle

To reduce the power fluctuations on the ignition period, the half cycle mode use the half periods as periods on / off.

Positive cycles and negatives are balanced to ensure that there are no DC components.

This firing mode is suggested for shortwave infrared lamp.

The following example describe the mode at 33%, 50% and 66%.

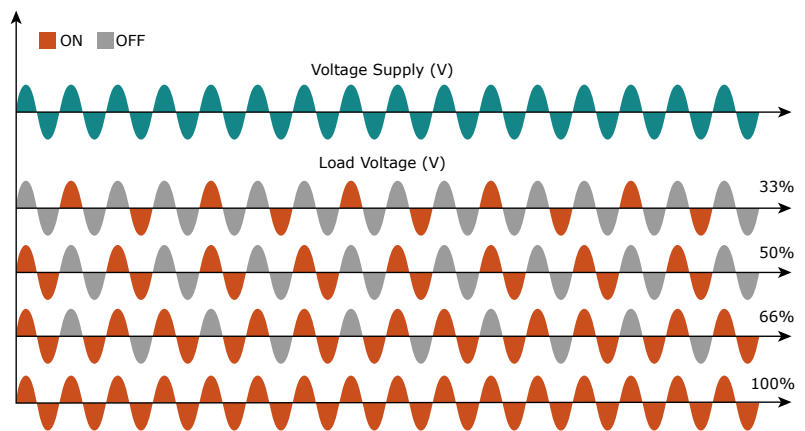

15 Heater bakeout function

When a heater insulated with magnesium oxide (MgO) is powered off, not in use or in storage for a long period of time, it can absorb moisture. If full power is applied, excessive current can damage the heater or blow fuses. The heater bakeout feature limits the voltage and current applied as the heater is brought back in to service. This drives moisture out of the heater and prevents blown fuses and damage to the heater.

15.1 Using Heater Bakeout

While the heater bakeout feature is active, the REVEX power controller ramps the current according to the user-set current and ramp time parameters for the heater bakeout function. The heater bakeout function does not ramp the output above the normal process set point. Once the function has run for the user-set time, the bakeout function terminates and the power controller attempts to perform control to set point normally.

Use Heater Bakeout Ramp Time to set the duration of the bakeout in minutes. Use Heater Bakeout Current to set the current to which the function attempts to ramp in Amperes. Use Heater Bakeout Off Time to set how many minutes the heater can be off before the bakeout function runs the next time the heater is used.

While performing the heater bakeout function, the power controller displays a message.

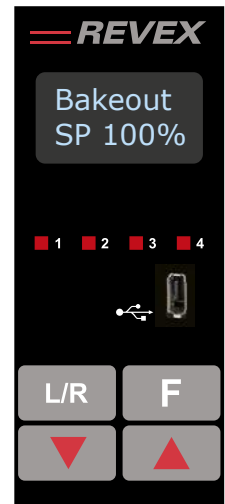

Heater bakeout Indication
 (only in Version with Display:
 Standard version or
 Option Code 5/6/7/9/A/C/F)

16

Control Mode (feed-back)

The Control Mode (feed-back) type has already configured in line with customer requirements that are defined in the Order Code. The Order Code is written on the identification label.

However, if you wish to change the Control Mode (feed-back) type you can use the software configurator or the Control Panel.



Caution: this procedure must be performed only by qualified persons.

The Control Mode (feed-back) type is defined by the parameter Control Mode (feed-back) in setup menu. If the configurable digital input has set like feed-back Selection, it's possible to change the select feed-back with the Voltage feed-back (V) simply activating the input.

It's possible to have:

 **V²** = Square Voltage feed-back.

The input signal is proportional to the output square voltage. This means that input signal becomes a power demand. The power remains constant if the load impedance doesn't change.

 **V** = Voltage feed-back.

The input signal is proportional to the output voltage. This means that input signal becomes a voltage demand. This control mode compensates the voltage fluctuation of the incoming line supply.

 **I** = Current feed-back.

The input signal is proportional to the current output. This means that input signal becomes a current demand. This control mode maintain the current also if the load impedance changes.

 **P(VxI)** = Power feed-back.

The input signal is proportional to the power output. This means that input signal becomes a power demand. The power remains constant also if voltage and load impedance change. This control mode is used with silicon carbide elements that change its resistive value with temperature and with age. In addition it compensates the voltage fluctuation of the incoming line supply.

 **I²** = Square Current feed-back.

The input signal is proportional to the output square current. This kind of feed-back is suggested for cold resistance applications.

 **None** = No feed-back Open Loop. The input is proportional to the firing angle (α).

 **External** = External feed-back (0÷10V, 4÷20mA, 0÷20mA).

The input signal is proportional to an external signal. This means that input signal becomes a demand to maintain this signal always constant. This control mode is used for example with galvanic systems, where it's necessary to control the current value through the electrodes.

17

Electronic boards

17.1 Supply the Electronic Board

The REVEX thyristor unit, to work, requires a voltage supply for the electronic boards of 24Vdc 1A on terminal M3 (1-; 2+).



Warning: Before connecting or disconnecting the unit check that power and control cables are isolated from voltage sources.

18 RS485 Serial port

M3 Terminal	Description
3	RS485 A+
4	RS485 B-

The serial communication port RS485 is available on the Command Terminals.

On this port may be done a network up to 127 REVEX.



Warning: It is not possible to remove the M3 connector when the unit is powered. Remove the AUX 24Vdc power supply before extracting the M3 connector.
Extracting the M3 connector with the AUX 24Vdc power supply connected to the M3 terminal could damage the unit

TOP VIEW

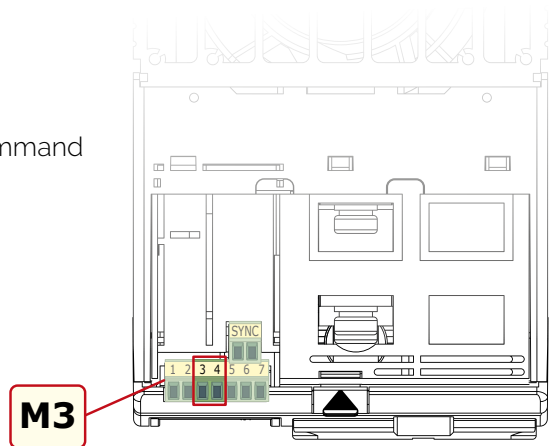

18.1 FIELD BUS Module

Technical Specification

- Up to n°14 REVEX can be connected for each terminal module
- Main process variable available
- 24Vdc Power Supply
- Simplified configuration

TU-RS485-TCP-3580MB



TU-RS485-PNT-067602

TU-RS485-EIP-067591



ORDER CODE	1	2	3	4	5	6	7	8	9	10	11	12	13	14	15	16
	T	U	-	R	S	4	8	5	-	-	-	-	-	-	-	-

COMMUNICATION	3	4	5	6	7
Modbus RTU	R	S	4	8	5

FIELDBUS, COMMUNICATION OR OTHER FUNCTIONS	8	9	10	11	12	13	14	15	16		
Modbus TCP Protocol Converter	-	T	C	P	-	3	5	8	0	M	B
Modbus TCP, Modbus Slave, IO, Data Logger, Logic	-	E	T	H	-	I	O	D	L	0	0
Profinet	-	P	N	T	-	0	6	7	6	0	2
Ethernet IP	-	E	I	P	-	0	6	7	5	9	1
RS232	-	2	3	2	-	3	5	8	0	2	W

19 Internal Fuse

The thyristor unit have internal fuse extrarapid at low I²t for the thyristor protection of against the short-circuits. The Fuses must have I²t 20% less than thyristor's I²t. The warranty of thyristor is null if no proper fuses are used.

Type	Fuse Code Spare Part	Current (A _{RMS})	Vac	FUSE I ² t value Suggested Azs (at 500V)*	FUSE I ² t value Suggested Azs (at 690V)	Qty for each phase
060	FU5007306.100 or FU5007306.110 or FU6.gURB17/100 (UL)	100 110 100	690	2170	4400 4400 3100	1
090	FU5007306.100 or FU5007306.110 or FU6.gURB17/100 (UL)	100 110 100	690	2170	4400 4400 3100	1

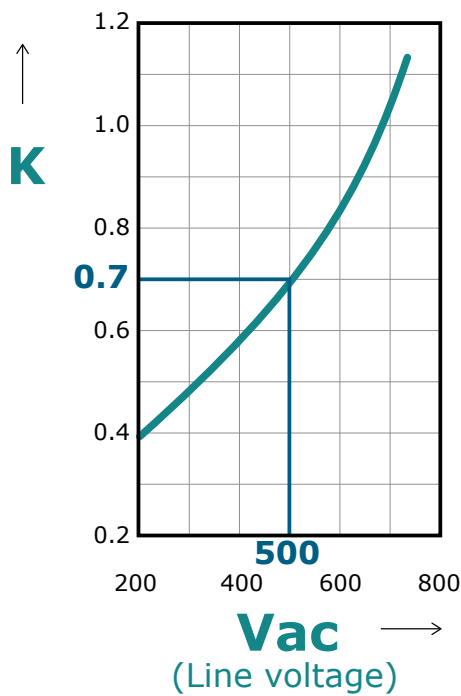

*I²t are multiplied for K value in function of Vac at 500V
K is equal to 0,7 (ex:3100 X 0,7 = 2170).
At 690Vac K is equal to 1.

Fuses replacement:

Open the cover and remove the screws, then replace it with the correct fuse, use the screws with a proper suggested torque indicated below.
Use correct screws M6 x 12 mm.

N° 2 M6x12mm for each fuse

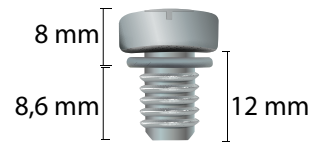

Type	Screw	Torque Lb-in (N-m)
60A-90A	M6	44.2 (5.0)



Caution: High speed fuses are used only for the thyristor protection and can not be used to protect the installation.



Caution: The warranty of thyristor is null if no proper fuses are used. See tab.



Warning: When powered, the thyristor unit is subject to dangerous voltages; disconnect from the power supply before opening the fuse box and touching electrical equipments.



CD Automation S.r.l.

Via Picasso, 34/36 - 20025 Legnano (MI)- Italy

Tel. +39 0331 577479 - Fax +39 0331 579479

E-mail: info@cdautomation.com - Web: www.cdautomation.com