

# USER'S MANUAL

Rev. 03/2023

**REVO C**  
THE CONNECTING UNIT  
**EXTENDED**

**3PH**

Solid-State Relay

1100A - 1400A

1600A - 1800A - 2100A

016

M-RC3-1100-2100



**CD Automation S.r.l.**

Via Picasso, 34/36 - 20025 Legnano (MI)- Italy

Tel. +39 0331 577479 - Fax +39 0331 579479

E-mail: [info@cdautomation.com](mailto:info@cdautomation.com) - Web: [www.cdautomation.com](http://www.cdautomation.com)



# Declaration of conformity

Declaration of conformity - Dichiarazione di Conformità



**PRODUCT MANUFACTURER / PRODUTTORE:**



**CD Automation S.R.L.**  
Controllers, Drives & Automation

Via Picasso, 34/36 - 20025 Legnano (MI)- Italy  
P.I. 08925720156 -Tel. +39 0331 577479 - Fax +39 0331 579479  
E-mail: info@cdautomation.com - Web: www.cdautomation.com

**Declare that the product / Dichiaro che il prodotto:**

**REVO C 3PH 1100A-1400A-1600A-1800A-2100A**

PRODUCT DESCRIPTION: Electric power control  
SCOPE OF APPLICATION: Thermal control process  
DESCRIZIONE DEL PRODOTTO: Unità di controllo potenza elettrica  
UTILIZZO: Controllo processi termici

**FULFILLS THE REQUIREMENTS OF THE STANDARD:**

Electrical safety Standard EN60947-1: 2007 + A1 2011, A2 2014  
EN60947-4-3: 2014  
Generic Emission standard EN60947-4-3: 2014 Group 1 Class A emissions  
Generic Immunity standard EN60947-4-3: 2014 Industrial Immunity  
Industrial electromagnetic environment 61326-1

**SODDISFA I REQUISITI DELLA NORMA:**

Specifica di sicurezza EN60947-1: 2007 + A1 2011, A2 2014  
EN60947-4-3: 2014  
Specifica sulle emissioni EN60947-4-3: 2014 gruppo 1 emissioni classe A  
Specifica sulle Immunità EN60947-4-3: 2014 Immunità industriale  
Ambiente elettromagnetico industriale 61326-1

CDAutomation declares that the products above mentioned are conforming to the directive  
CDAutomation dichiara che i prodotti sopra menzionati sono conformi alla direttiva  
Bassa Tensione (low Voltage)

**Low Voltage Directive updated 2014/35/EU**  
**EMC directive updated 2014/30/EU**

Issued on: 03/03/2023  
Data di emissione: 03/03/2023

Amministratore Unico e  
Legale Rappresentante

**Simone Brizzi**



# Declaration of conformity

Declaration of conformity - Dichiarazione di Conformità



**PRODUCT MANUFACTURER / PRODUTTORE:**



**CD Automation S.R.L.**  
Controllers, Drives & Automation

Via Picasso, 34/36 - 20025 Legnano (MI)- Italy  
P.I. 08925720156 -Tel. +39 0331 577479 - Fax +39 0331 579479  
E-mail: info@cdautomation.com - Web: www.cdautomation.com

**Declare that the product / Dichiaro che il prodotto:**

**REVO C 3PH 1100A-1400A-1600A-1800A-2100A**

PRODUCT DESCRIPTION: Electric power control  
SCOPE OF APPLICATION: Thermal control process  
DESCRIZIONE DEL PRODOTTO: Unità di controllo potenza elettrica  
UTILIZZO: Controllo processi termici

**FULFILLS THE REQUIREMENTS OF THE STANDARD:**

Electrical safety Standard EN60947-1: 2007 + A1 2011, A2 2014  
EN60947-4-3: 2014  
Generic Emission standard EN60947-4-3: 2014 Group 1 Class A emissions  
Generic Immunity standard EN60947-4-3: 2014 Industrial Immunity  
Industrial electromagnetic environment 61326-1

**SODDISFA I REQUISITI DELLA NORMA:**

Specifica di sicurezza EN60947-1: 2007 + A1 2011, A2 2014  
EN60947-4-3: 2014  
Specifica sulle emissioni EN60947-4-3: 2014 gruppo 1 emissioni classe A  
Specifica sulle Immunità EN60947-4-3: 2014 Immunità industriale  
Ambiente elettromagnetico industriale 61326-1

CDAutomation declares that the products above mentioned are conforming to the directive  
CDAutomation dichiara che i prodotti sopra menzionati sono conformi alla direttiva  
Bassa Tensione (low Voltage)

**Low Voltage Directive updated 2014/35/EU**  
**EMC directive updated 2014/30/EU**

Issued on: 03/03/2023  
Data di emissione: 03/03/2023







Amministratore Unico e  
Legale Rappresentante  
**Simone Brizzi**

# Important warnings for safety

This chapter contains important information for the safety. The not observance of these instructions may result in serious personal injury or death and can cause serious damages to the Thyristor unit and to the components system included.

*The installation should be performed by qualified persons.*

In the manual are used symbols to give more evidence at the notes of safety and operativity for the attention for the user:

	This icon is present in all the operational procedures where the Improper operation may result in serious personal injury or death by Electrical Shock Hazard Symbol (a lightning bolt in a triangle) precedes an electric shock hazard CAUTION or WARNING safety statement.
	Warning or Hazard that needs further explanation than the label on unit can provide. Consult User's Guide for further information.
	Unit is compliant with European Union directives. See Declaration of Conformity for further details on Directives and Standards used for Compliance.
	If available, unit is a Listed device per Underwriters Laboratories. It has been investigated to ANSI/UL® 508 standards for Industrial Control Switches and equivalent to CSA C22.2 #14. For more detail search for File E231578 on <a href="http://www.ul.com">www.ul.com</a>
	ESD Sensitive product, use proper grounding and handling techniques when installing or servicing product.
	Do not throw in trash, use proper recycling techniques or consult manufacturer for proper disposal.

A **“NOTE”** marks a short message to alert you to an important detail.





A **“CAUTION”** safety alert appears with information that is important for protecting your equipment and performance. Be especially careful to read and follow all cautions that apply to your application.





















A **“WARNING”** safety alert appears with information that is important for protecting you, others and equipment from damage. Pay very close attention to all warnings that apply to your application.

## Safety notes

 **WARNING!** To avoid damage to property and equipment, injury and loss of life, adhere to applicable electrical codes and standard wiring practices when installing and operating this product. Failure to do so could result in damage, injury and death.

 **AVERTISSEMENT!** Pour éviter d'endommager la propriété et l'équipement, les blessures et la perte de vie, respecter les codes électriques en vigueur et les pratiques de câblage standard au moment de l'installation et de l'utilisation de ce produit. Dans le cas contraire, cela peut entraîner la mort, des blessures graves ou des dommages.

-  **WARNING!** All service including inspection, installation, wiring, maintenance, troubleshooting, fuse or other user serviceable component replacement must be performed only by properly qualified personnel. Service personnel must read this manual before proceeding with work. While service is being performed unqualified personnel should not work on the unit or be allowed in the immediate vicinity.
-  **AVERTISSEMENT!** Tous les services, y compris l'inspection, l'installation, le câblage, l'entretien, le dépannage, le remplacement de fusibles ou d'autres composants pouvant être réparés par l'utilisateur, doivent être effectués uniquement par un personnel d'entretien qualifié. Le personnel de service doit lire ce manuel avant d'effectuer tout travail. Pendant que l'entretien est exécuté, tout personnel non qualifié ne doit effectuer de travail sur l'appareil ni se trouver à proximité.
-  **WARNING!** When in use the power controller is connected to dangerous voltages. Do not remove the protective covers without first disconnecting and preventing power from being restored while servicing the unit.
-  **AVERTISSEMENT!** Au moment de l'utilisation, le régulateur de puissance est connecté à des tensions dangereuses. Ne retirer aucun couvercle de protection sans d'abord débrancher l'appareil et ainsi empêcher l'alimentation d'être rétablie pendant l'entretien.
-  **WARNING!** Do not use in aerospace or nuclear applications.
-  **AVERTISSEMENT!** Ne pas utiliser pour les applications aérospatiales ou nucléaires.
-  **WARNING!** The units are not developed to manage capacitive loads.
-  **AVERTISSEMENT!** Les unités ne sont pas développées pour la conduite de charges capacitatives.
-  **WARNING!** The power controller's protection rating is IP20 with all covers installed and closed. It must be installed in an enclosure that provides all the necessary additional protections appropriate for the environment and application.
-  **AVERTISSEMENT!** L'indice de protection du régulateur de puissance est de IP20 lorsque les couvercles sont installés et fermés. L'appareil doit être installé dans une enceinte qui assure toute la protection supplémentaire nécessaire pour l'environnement et l'application.
-  **WARNING!** Ground the power controller via the provided protective earth grounding terminal. Verify ground is within impedance specifications. This should be verified periodically.
-  **AVERTISSEMENT!** Mise à la terre du régulateur de puissance par le biais de la borne de prise de terre de protection fournie. Vérifier que la prise de terre est conforme aux spécifications de l'impédance. Cela doit être vérifié périodiquement.
-  **WARNING!** Electric Shock Hazard: when the power controller has been energized, after shutting off the power, wait at least one minute for internal capacitors to discharge before commencing work that brings you in to contact with power connections or internal components.
-  **AVERTISSEMENT!** Risque de décharges électriques: lorsque le régulateur de puissance est mis sous tension, après avoir été éteint, attendre au moins une minute pour que les condensateurs internes se déchargent avant de commencer tout travail incluant le contact avec les connexions électriques ou les composants internes.
-  **WARNING!** The installation must be protected by electromagnetic circuit breakers or by fuses. The semiconductor fuses located inside the power controller are classified for UL as supplementary protection for semiconductor devices. They are not approved for branch circuit protection.
-  **AVERTISSEMENT!** L'installation doit être protégée par des disjoncteurs électromagnétiques ou des fusibles. Les fusibles pour semi-conducteurs situés à l'intérieur du régulateur de puissance sont classés UL comme protection supplémentaire pour les dispositifs pour semi-conducteurs. Ils ne sont pas approuvés pour la protection des circuits de dérivation.
-  **WARNING!** When making live voltage or current measurements, use proper personal protective equipment for the voltages and arc-flash potentials involved.

-  **AVERTISSEMENT!** Au moment de relever des mesures de tension ou de courant en direct, utiliser un équipement de protection individuelle approprié pour les tensions et les potentiels d'arc électrique concernés.
-  **WARNING!** Verify the voltage and current ratings of the power controller are correct for the application.
-  **AVERTISSEMENT!** Vérifier que les valeurs de tension et de courant du régulateur de puissance sont correctes pour l'application.
-  **CAUTION:** To avoid compromising the insulation, do not bend wire or other components beyond their bend radius specifications.
-  **ATTENTION:** Pour éviter de compromettre l'isolation, ne pas plier le fil ou tout autre composant au-delà de ses spécifications en matière de rayon de courbure.
-  **CAUTION:** Protect the power controller from high temperature, humidity and vibrations.
-  **ATTENTION:** Protéger le régulateur de puissance contre les températures élevées, l'humidité et les vibrations.
-  **CAUTION:** The power controller warranty is void if the tested and approved fuses are not used.
-  **ATTENTION:** La garantie du régulateur de puissance est nulle si aucun fusible testé et approuvé n'est utilisé.
-  **CAUTION:** Only trained and authorized personnel should access and handle the internal electronics and they must follow proper electro-static prevention procedures.
-  **ATTENTION:** Seul le personnel formé et autorisé peut accéder aux composants électroniques internes et les gérer, et il doit se conformer à des procédures de prévention électrostatique appropriées.
-  **CAUTION:** Install an appropriately sized RC filter across contactor coils, relays and other inductive loads.
-  **ATTENTION:** Installer un filtre RC de dimensions appropriées sur les bobines du contacteur, les relais et autres charges par induction.
-  **CAUTION:** The thyristor units here described have been designed for use with sinusoidal networks with nominal frequency 50-60 Hz. Any application with NON-SINUSOIDAL, distorted or disturbed networks could compromise the correct operation of the unit.
-  **ATTENTION:** Les unités de thyristors décrites ici ont été conçues pour être utilisées avec des réseaux sinusoïdaux d'une fréquence nominale de 50 à 60 Hz. Toute application utilisant des réseaux NON SINUSOÏDAUX, déformés ou perturbés peut compromettre le bon fonctionnement de l'appareil.
-  **NOTE:** Provide a local disconnect to isolate the power controller for servicing.
-  **REMARQUE:** Fournir une déconnexion locale afin d'isoler le régulateur de puissance pour l'entretien.
-  **NOTE:** The nominal current is specified for ambient temperatures at or below 40° C. Ensure the application design allows for adequate cooling of each power controller. The power controller must be mounted vertically. The cooling design must prevent air heated by one power controller from causing power controllers mounted above to exceed the ambient operating temperature limit. When power controllers are mounted side by side allow a minimum spacing of 15mm between them.
-  **REMARQUE:** Le courant nominal est précisé pour des températures ambiantes égales ou inférieures à 40°C. S'assurer que la conception de l'application permette le refroidissement adéquat de chaque régulateur de puissance. Le régulateur de puissance doit être monté verticalement. La conception de refroidissement doit empêcher l'air chauffé par le régulateur de puissance de dépasser la limite de température de fonctionnement ambiante de la part des régulateurs de puissance montés au-dessus. Lorsque les régulateurs de puissance sont montés côte à côte, il faut conserver un espacement minimal de 15 mm entre les deux.
-  **NOTE:** Use only copper cables and wires rated for use at 75°C or greater.
-  **REMARQUE:** N'utiliser que des câbles et des fils en cuivre pour l'utilisation à 75°C ou plus.





## Maintenance

In order to have a corrected cooling, the user must clean the heat-sink and the protective grill of the fans. The frequency of this servicing depends on environmental pollution.

Also check periodically if the screw for the power cables and safety earth are tightened correctly (See Connection Diagram)

### Warranty condition

Producer gives a 12 months warranty to its products.

The warranty is limited to repairing and parts substitution in our factory and does exclude products not properly used and fuses.

Warranty does not include products with serial numbers deleted. The faulty product should be shipped to Producer at customer's cost and our Service will evaluate if product is under warranty terms.

Substituted parts remain of Producer property.



CD Automation srl assumes no liability for any damage to persons or property deriving from tampering, from incorrect or improper use, or from any use not conforming to the characteristics of the controller and to the instructions in this User Manual.



## Return Material Authorization (RMA)

Customers wishing to return any items, whether they are incorrectly supplied, faulty or damaged in transit, must first complete a Return Material Authorisation (RMA) form to obtain an RMA number from the Service Department.

A full repair service is available for customers. Prior to submitting the RMA form and returning products, customers are recommended to contact the technical support team to determine whether the issue can be resolved with telephone support.

### How the RMA service works

The RMA form and details are available on our web sites:

<https://www.cdautomation.com/rma-english-version/>

When completing the RMA form, please be as specific as possible about the problem, including any pertinent application details. The more information given, the more quickly and more thoroughly the problem can be solved. The minimum information required is:

1. The Full Model Number
2. Quantity of units being returned
3. The units Serial Number(s)
4. A description of the problem ("faulty" or "unknown" is not sufficient)



# Summary

- Declaration of conformity . . . . . 2
- Important warnings for safety . . . . . 4
- Maintenance . . . . . 7
- Introduction . . . . . 10
- 1 Advantages compared with analog thyristor unit . . . . . 11
  - 1.1 Overview . . . . . 11
- 2 Software Configurator . . . . . 12
- 3 Quick Start . . . . . 13
- 4 Basic Connections and sizing . . . . . 14
- 5 Identification and Order Code . . . . . 15
  - 5.1 Identification of the unit. . . . . 15
- 6 Technical Specifications . . . . . 18
  - 6.1 General features . . . . . 18
  - 6.2 Input features. . . . . 18
  - 6.3 Output features 600V. . . . . 18
  - 6.4 Output features 690V. . . . . 19
  - 6.5 Environmental installation conditions. . . . . 19
  - 6.6 Derating Curve and Thermal conditions . . . . . 19
  - 6.7 Calculating flow capacity of the fan. . . . . 20
  - 6.8 Wi-Fi Transmitter Module . . . . . 20
- 7 Installation . . . . . 21
  - 7.1 Dimensions and Weight. . . . . 22
  - 7.2 Fixing holes . . . . . 23
  - 7.3. Lifting the unit . . . . . 24
- 8 Wiring instructions . . . . . 25
  - 8.1 Terminals Positions . . . . . 25
  - 8.2 Power Terminals . . . . . 26
  - 8.3 IP20 Cover OPTION . . . . . 28
  - 8.4 Power connection dimensions (suggested). . . . . 29
  - 8.5 Cable dimensions (suggested) of Earth and of the Command Terminals . . . . . 30
  - 8.6 Commmand Terminals . . . . . 31
  - 8.7 Fan Supply For Each Phase (MX1 – MX2 - MX3). . . . . 33
  - 8.8 Thermal Switch For Each Phase (MX1 – MX2 - MX3). . . . . 33
  - 8.9 Schematic. . . . . 34
  - 8.10 Connection Diagram for 3 phases (control on 3 phases) . . . . . 37
- 9 Control Panel. . . . . 38
  - 9.1 Menu navigation . . . . . 39
  - 9.2 Control Panel Led . . . . . 40
  - 9.3 Displayed alarms . . . . . 40
  - 9.4 Parameter list. . . . . 41
- 10 Using the Configurator . . . . . 56
  - 10.1 Typical Uses . . . . . 56
  - 10.2 Communicating with Power Controllers . . . . . 56
  - 10.3 Recipes . . . . . 56
  - 10.4 How to. . . . . 56



- 10.5 Using the Configurator . . . . . 58
- 10.6 Software General information . . . . . 61
- 11 Configurable inputs and Outputs. . . . . 68**
  - 11.1 Digital Inputs . . . . . 68
  - 11.2 Analog Input 1: Set Point . . . . . 68
  - 11.3 Analog Input 2: Set Point, Feedback or Current Limit Set Point . . . . . 69
  - 11.4 Alarms and Alarm Relay Output . . . . . 69
- 12 Alarm description. . . . . 70**
  - 12.1 Heater Break Alarm. . . . . 70
  - 12.2 AUX High . . . . . 71
  - 12.3 AUX Low . . . . . 71
  - 12.4 ComError . . . . . 71
  - 12.5 AUX Line Loss . . . . . 71
  - 12.6 I Limit . . . . . 71
  - 12.7 SD Error . . . . . 71
  - 12.8 SHRT. . . . . 71
  - 12.9 SCR Temp . . . . . 71
  - 12.10 Line Loss . . . . . 71
  - 12.11 Phase Loss . . . . . 71
- 13 "Enable" Function in static Unit . . . . . 72**
  - 13.1 Using Digital Input only . . . . . 72
  - 13.2 Using Serial Port RS485 only. . . . . 73
  - 13.3 Using Digital Input + Serial Port RS485. . . . . 73
  - 13.4 Using FieldBus only . . . . . 74
  - 13.5 Using Digital Input + FieldBus . . . . . 75
- 14 Firing type. . . . . 76**
  - 14.1 Zero Crossing . . . . . 76
  - 14.2 Single Cycle . . . . . 76
  - 14.3 Burst Firing . . . . . 76
  - 14.4 Soft Start with Burst Firing . . . . . 77
  - 14.5 Phase Angle . . . . . 77
  - 14.6 Soft Start with Phase Angle . . . . . 77
  - 14.7 Delay Triggering with Burst Firing . . . . . 78
- 15 Current Limit . . . . . 79**
  - 15.1 Current Limit Setting . . . . . 79
  - 15.2 Current Limit tuning procedure . . . . . 80
- 16 Heater bakeout function . . . . . 81**
  - 16.1 Using Heater Bakeout . . . . . 81
- 17 Control Mode (feed-back) . . . . . 82**
- 18 Phase: access and substitution . . . . . 83**
- 19 Electronic Board: access and substitution . . . . . 84**
- 20 Supply the Electronic Board . . . . . 85**
  - 20.1 Fuse Board protection . . . . . 86
- 21 24Vdc input Auxiliary supplemental power . . . . . 87**
- 22 RS485 Serial port . . . . . 88**
- 23 Fieldbus communication option . . . . . 88**
- 24 Internal Fuse . . . . . 89**



## Introduction

A thyristor unit is semiconductor device which acts as a switch formed by two thyristors in antiparallel. To switch on the alternating current the input signal will be on and the thyristor will switch off at first Zero Crossing voltage with no input signal.

The benefits of thyristor units compared with electromechanical contactors are numerous: no moving parts, no maintenance and capacity to switch very fast. Thyristors are the only solution to control transformers and special loads that change resistance with temperature and with age.

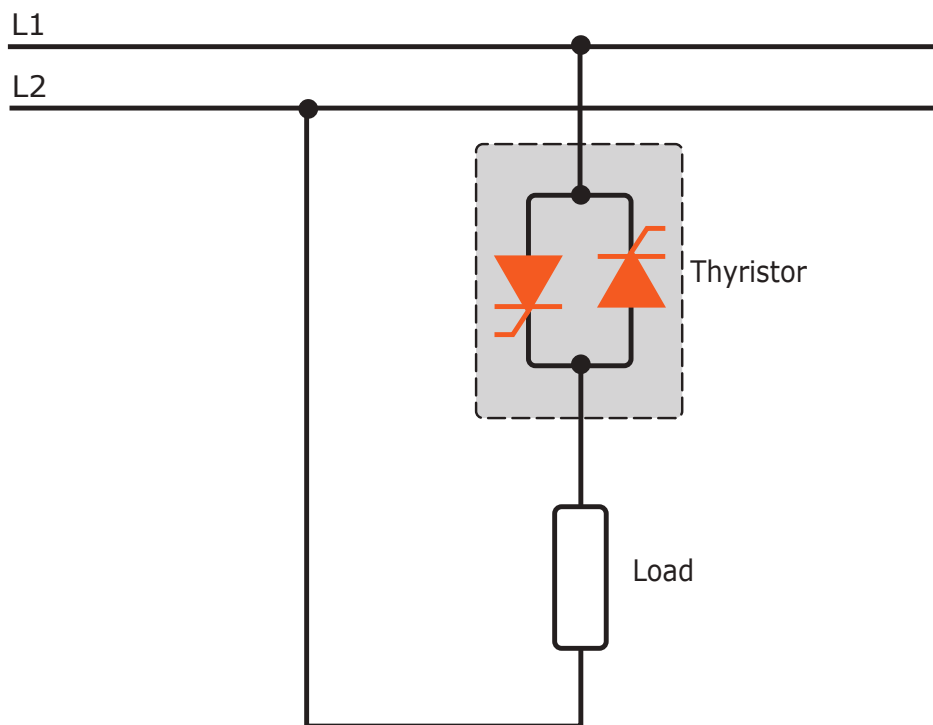

1

## Advantages compared with analog thyristor unit

Communication RS485 is a standard feature of REVO C this allows the use of many information like: current, power, load state and all the parameters for diagnostic and configuration. Ulterior advantages of the digital system vs the analogical is the flexibility and the possibility of implement special characteristics without change the hardware. Several strategies can be implemented and selected through the configuration parameters. With software configuration, you can have access to the configuration parameters. To connect the Thyristor unit to the computer use a micro USB cable.



### 1.1 Overview

#### Heater bakeout

- Protects heater upon start up
- Eliminates labor and time associated with checking for wet heaters

#### Integrated semiconductor fusing, current transformer and user interface

- Saves installation time and eases setup and commissioning
- Delivers a user-friendly, intuitive interface

#### Industry-leading design and serviceability

- Offers a robust SCR design to meet a rugged industrial environment's high quality and reliability needs
- Provides quick and easy access to maintain and service fuses and individual legs in minimal time
- Enables fast troubleshooting by providing helpful thermal system diagnostics

#### Comprehensive power controller range

- Provides wide range of options from simple single phase to complex three-phase loads to 690V

#### 100kA short circuit current rating (SCCR) (Not reviewed by UL®)

- Enables greater protection in the event of a short circuit

#### UL® 508 Listed

- Shortens project schedules, agency testing and expenses

#### Control modes: contactor, voltage, current or power

- Satisfies a wide range of demanding thermal applications

#### Load firing modes: zero-cross, burst fire, phase angle, soft start, half-cycle, single-cycle, delayed triggering

- Handles a wide range of load types including nichrome, medium and long waveform infrared lamps, moly, transformers, silicon carbide, UV lamps and tungsten
- Protects and extends the life of connected loads

#### Wide range of communication protocols

- Enable factory and process automation with connectivity to process and equipment data via Modbus® RTU, Modbus® TCP, Wi-Fi, Profibus, Profinet, USB device (configuration and data file transfers)

#### Open heater and shorted SCR indication

- Minimizes production downtime with easy to understand, intelligent, troubleshooting diagnostics

#### Integrated USB and user interface for configuration

- Easily and safely program configuration settings as the user interface can be powered through USB connection
- Eliminates need to work in a high voltage hazard environment. High voltage to the power controller and system panel can be shut off and locked out for safety while configuring controller.

#### Easy access and replacement for

- the Power Units complete with fuses
- the Drive Board complete with all the electronic boards already configured.

## 2 Software Configurator

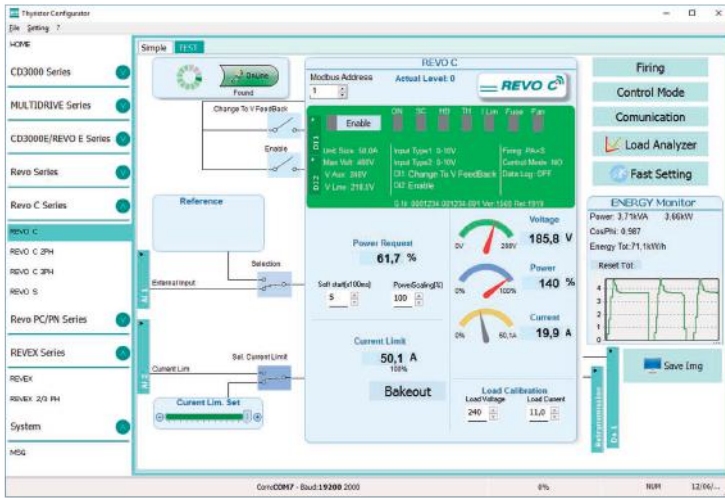

Thyristor configurator software is free and is possible download it from our site.

If the Order Code is in line with requirement, then unit has been already configured in Factory and it's ready to use.

You need the software only to modify the ordered configuration. Anyway we suggest to check the unit on the machine with the "Test unit" section.

For install the software, launch the program and follow the instructions on the screen.

Run the software configurator and set the correct serial port number by menu setting-serial com – port number.

**Software Configurator download link:**

[https://www.cdautomation.com/wp-content/uploads/ThyristorConfigurator\\_ver6.zip](https://www.cdautomation.com/wp-content/uploads/ThyristorConfigurator_ver6.zip)

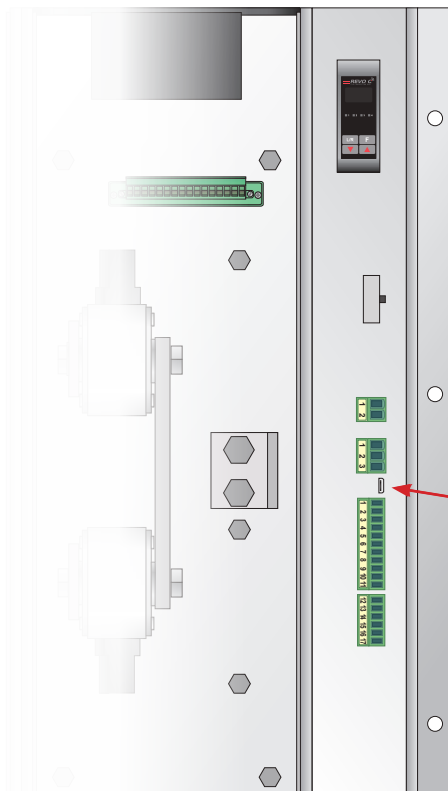

To connect the unit at the PC, it's necessary to use the micro USB 2.0 Modbus RTU cable. USB connection need a driver to work properly, you can find it from our site. However the configuration software installer will install as default the correct driver.

**Micro USB**

## 3

## Quick Start



**Attention:** this procedure must be carried out by skilled people only.

If your REVO C code is in line with what you really need, then the main configuration is already done by Producer and you just need to do the following steps:

1. Verify REVO C current sizing. Be sure that:
  - the load current is equal or less than the nominal one of REVO C
  - the main voltage is equal or less than the nominal voltage of REVO C
2. Verify the Installation
3. Verify the Wiring:
  - all auxiliary connections must be done in line with wirings on this manual
  - verify that there isn't a short circuit on the load
4. Supply the Unit
5. Go in the **Operator menu**  
Set the parameters **Operative Load Voltage** and **Nominal Current of the load** using the frontal keypad or Thyristor configurator software.

***The Unit is ready to work***

***The auxiliary voltage supply of the REVO C unit must be synchronized with load voltage power supply.***

*If the Auxiliary Voltage (written on the identification label) is different from Supply Voltage (to the load), use an external transformer.*

### IMPORTANT

**Suggested Starting Strategy (Enable) (See Chapter 13):**

- 1: Feed the unit with L1-L2-L3 power voltage supply
- 2: Feed the auxiliary supply
- 3: Close the Enable contact to start with the regulation

If your REVO C code is NOT in line with what you really need, use the enclosed configurator software tool to set-up the unit. Install the software on your PC, select REVO C and click on test unit changing what you need.

# 4 Basic Connections and sizing

Star wiring with resistive load (control on three phases with REVO C-3PH)

$$I = \frac{P}{1,73V}$$

- V = Nominal voltage of the load
- I = Nominal current of the load
- P = Nominal power of the load

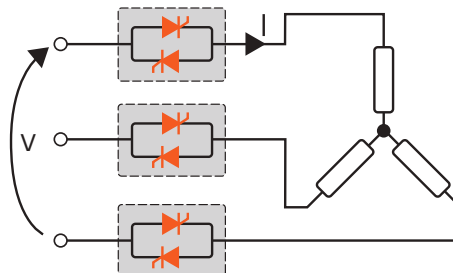

Star wiring with resistive load + Neutral (control on three phases with REVO C-3PH)

$$I = \frac{P}{1,73V}$$

- V = Nominal voltage of the load
- I = Nominal current of the load
- P = Nominal power of the load

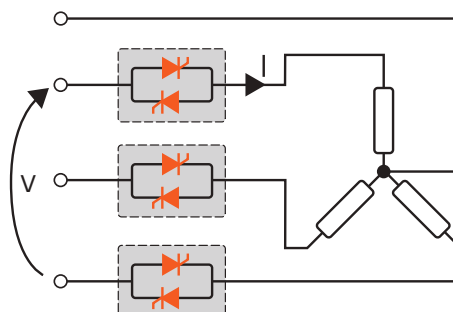

Delta wiring with resistive load (control on three phases with REVO C-3PH)

$$I = \frac{P}{1,73V}$$

- V = Nominal voltage of the load
- I = Nominal current of the load
- P = Nominal power of the load

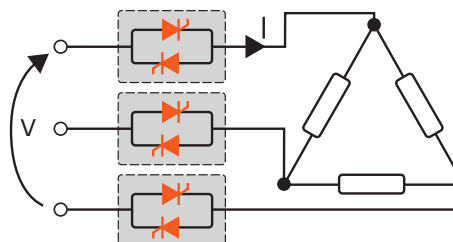

Open Delta wiring with resistive load (control on three phases with REVO C-3PH)

$$I = \frac{P}{3V}$$

- V = Nominal voltage of the load
- I = Nominal current of the load
- P = Nominal power of the load

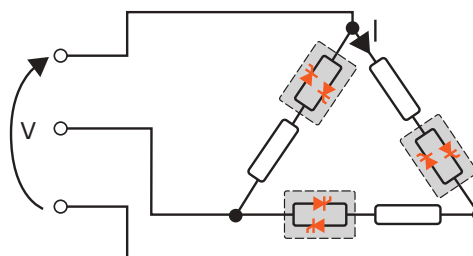

# 5 Identification and Order Code

## 5.1 Identification of the unit



**Caution:** Before to install, make sure that the Thyristor unit have not damages. If the product has a fault, please contact the dealer from which you purchased the product.

The identification's label give all the information regarding the factory settings of the Thyristor unit, this label is on the unit, like represented in figure.

Verify that the product is the same thing as ordered.





### 5.1.1 Order code

	1	2	3	4	5	6	7	8	9	10	11	12	13	14	15	16
REVO C 3PH	R	C	3	-	-	-	-	-	-	-	-	-	-	-	-	-

CURRENT		FUSES		
description	description	4	5	6
		code		note
1100A	Fixed Fuses Included	1	1	H
1400A	Fixed Fuses Included	1	4	H
1600A	Fixed Fuses Included	1	6	H
1800A	Fixed Fuses Included	1	8	H
2100A	Fixed Fuses Included	2	1	H

MAX VOLTAGE		7
description	description	code
		note
480V		4
600V		6
690V		7

AUX SUPPLY VOLTAGE		AUX VOLTAGE RANGE		8
description	description	code		note
100/120Vac	90 to 135Vac	1		
200/208/230/240Vac	180 to 265Vac	2		

MAIN INPUT		9
description	description	code
		note
SSR		S
0.20mA		B
4.20mA		A
0.10V		V
10KPot		K

FIRING		START OPTION		10
description	description	code		note
Burst Firing	No Soft Start	B		
	Linear Soft Start	J		
Phase Angle	No Soft Start	P		
	Linear Soft Start	E		
Delayed Triggering		D		
Zero Crossing	No Soft Start	Z		
	Linear Soft Start	R		

CONTROL MODE		11
description	description	code
		note
Open Loop		0
Voltage		U
Voltage Square		Q
Current		I
Current Square		A
Power Vxl		W
External feedback		X

OPTION		12
description	description	code
		note
No Option		0
Option code - see table		...

FAN VOLTAGE		13
description	description	code
		note
Fan 115Vac		1
Fan 230Vac Std Version		2

APPROVALS		14
description	description	code
		note
CE EMC For European Market - IP protection rating = 0		0
CE EMC For European Market - IP protection rating = 20		1
UL + CE EMC For European Market - IP protection rating = 0		2
UL + CE EMC For European Market - IP protection rating = 20		L

LOAD TYPE		15
description	description	code
		note
Normal Resistance		0
IRSW Infrared Short Wave		1
MoSi2 Heaters		2
SiC Heaters		3
Transformer Coupled with Normal Resistance		4
Transformer Coupled with MoSi2 Heaters		5
Transformer Coupled with SiC Resistance		6
Transformer Coupled with UV Lamp		7

COMMUNICATION AND RETRANSMISSION		16
description	description	code
		note
N'1 Modbus® RTU	No Retransmission	0
	Retransmission 4:20mA	1
	Retransmission 0:10V	2
N'2 Modbus® RTU	No Retransmission	3
	Retransmission 4:20mA	4
	Retransmission 0:10V	5
N'1 Profibus® DP + N'1 Modbus® RTU	No Retransmission	6
	Retransmission 4:20mA	7
	Retransmission 0:10V	8
N'1 Profinet® IO + N'1 Modbus® RTU	No Retransmission	9
	Retransmission 4:20mA	A
N'1 Modbus® TCP + N'1 Modbus® RTU	Retransmission 0:10V	B
	No Retransmission	C
	Retransmission 4:20mA	D
N'1 Ethernet IP + N'1 Modbus® RTU	Retransmission 0:10V	E
	No Retransmission	F
	Retransmission 4:20mA	G
	Retransmission 0:10V	H

**Note (1):** This configuration is possible only with Delayed Triggering or Phase Angle Firing

**Note (2):** This configuration is possible only with Phase Angle Firing

### 5.1.2 Option Code

I LIMIT	HB	WIFI	LOGGING	TOTALIZER	CODE	NOTES
					0	
					1	
					2	
					3	
					4	
					5	
					6	
					7	
					8	
					9	
					A	
					B	
					C	
					D	
					E	
					F	
					G	
					H	
					I	
					J	
					K	
					L	
					M	
					N	
					O	
					P	
					Q	
					R	
					S	
					T	
					U	
					V	

**I LIMIT (CURRENT LIMIT)** This option is used to keep the overcurrent inside setted limit. It's necessary to drive primary transformers and cold resistance.

**HB** Alarm for partial or total load failure and Short Circuit on SCR (relay output).

**WiFi** Option that allows communication with a smart phone. From your smart phone via the CD Automation App, direct to your thyristor unit in the cabinet to read current, voltage, power and energy totalization as well as the ability to change parameters to improve process and product quality without opening the cabinet door.

**APP** Free of charge download it from Google Play or Apple Store.

**DATA LOGGER** This feature is important to see the historical data of parameter like Current, Voltage and Power and can be useful to diagnose a fault.

**ENERGY TOTALIZER** This function totalize the energy consumption of the load allowing the calculation cost of heat treatment.

# 6 Technical Specifications

## 6.1 General features

Operative voltage: 480V +10% max -10% min  
 600V +10% max -10% min  
 690V +10% max -10% min

Utilization Category: AC-51

IP Code: 00 (IP20 on request)

Method of Connecting: Load in Delta, Load in Star

Auxiliary voltage:

Order code RC3\_ \_ \_ -\_1 = line voltage 100/120V transformer range 90:135V (8 VA Max)

Order code RC3\_ \_ \_ -\_2 = line voltage 200/208/220/230/240V transformer range 180:265V (8 VA Max)

Relay output for Heater Break Alarm: 0.5A a 125VAC  
 (only with HB option)

## 6.2 Input features

Digital Input: 4 ÷ 30Vdc 5mA Max (ON ≥4Vdc OFF <1Vdc) 0.5Hz max

Volt Analogic input: 0 ÷ 10Vdc impedance 15 kΩ

Current Analogic input: 0 ÷ 20mA impedance 100 Ω  
 4 ÷ 20mA impedance 100 Ω

Potentiometer: 10 kΩ min.

Logic input SSR (Fast Enable): 4 ÷ 30Vdc 5mA Max (ON ≥4Vdc OFF <1Vdc)  
 duty cycle min. 100 ms max 3Hz

## 6.3 Output features 600V

Current (A)	Output Voltage range (Ue) (V)	Repetitive peak reverse voltage (Uimp) (up to 600V)	Latching current (mAeff)	Max peak one cycle (10msec.) (A)	Leakage current (mAeff)	FUSE I <sup>2</sup> T value Suggested A <sup>2</sup> s (at 660V) tp=10msec	Frequency range (Hz)	Power loss Thyristor + Fuse I=Inom (W)	FANS (230Vac Standard) (115Vac Option)		
									N°	W	m3/h
1100A	24÷600	1800	700	22400	300	480.000	47÷70	4047	3	225 (75 x 3 Fan)	2340 (780 x 3 Fan)
1400A	24÷600	1800	700	22400	300	1.750.000	47÷70	5469	6	450 (75 x 6 Fan)	4680 (780 x 6 Fan)
1600A	24÷600	1600	700	26900	300	2.200.000	47÷70	5583	6	450 (75 x 6 Fan)	4680 (780 x 6 Fan)
1800A	24÷600	1800	700	36000	300	2.200.000	47÷70	6243	6	450 (75 x 6 Fan)	4680 (780 x 6 Fan)
2100A	24÷600	1600	700	38000	300	3.700.000	47÷70	7083	6	450 (75 x 6 Fan)	4680 (780 x 6 Fan)

### 6.4 Output features 690V

Current (A)	Output Voltage range (Ue) (V)	Repetitive peak reverse voltage (Uimp) (up to 690V)	Latching current (mAeff)	Max peak one cycle (10msec.) (A)	Leakage current (mAeff)	FUSE I <sup>2</sup> T value Suggested Azs (at 660V) tp=10msec	Frequency range (Hz)	Power loss Thyristor + Fuse I=Inom (W)	FANS (230Vac Standard) (115Vac Option)		
									N°	W	m3/h
1100A	24÷690	2200	700	36000	300	1.900.000	47÷70	4047	3	225 (75 x 3 Fan)	2340 (780 x 3 Fan)
1400A	24÷690	2200	700	36000	300	3.300.000	47÷70	5469	6	450 (75 x 6 Fan)	4680 (780 x 6 Fan)
1600A	24÷690	2200	700	36000	300	3.900.000	47÷70	5583	6	450 (75 x 6 Fan)	4680 (780 x 6 Fan)
1800A	24÷690	2200	700	60000	300	3.900.000	47÷70	6243	6	450 (75 x 6 Fan)	4680 (780 x 6 Fan)
2100A	24÷690	2200	700	60000	300	3.900.000	47÷70	7083	6	450 (75 x 6 Fan)	4680 (780 x 6 Fan)

### 6.5 Environmental installation conditions

- Ambient temperature: 0-40°C (32-104°F) at nominal current. Over 40°C -104°F use the derating curve (max 50°C).
- Storage temperature: -25°C to 70°C -13°F to 158°F
- Installation place: Don't install at direct sun light, where there are conductive dust, corrosive gas, vibration or water and also in salty environmental.
- Altitude: Up to 1000 meter over sea level. For higher altitude reduce the nominal current of 2% for each 100m over 1000m
- Humidity: From 5 to 95% without condense and ice
- Pollution Level: Up to 2nd Level ref. IEC 60947-1 6.1.3.2

### 6.6 Derating Curve and Thermal conditions

The nominal current of the units in specification are referred to continuous service at 40°C ambient temperature. For higher temperature multiply the nominal current times derating coefficient K below represented:

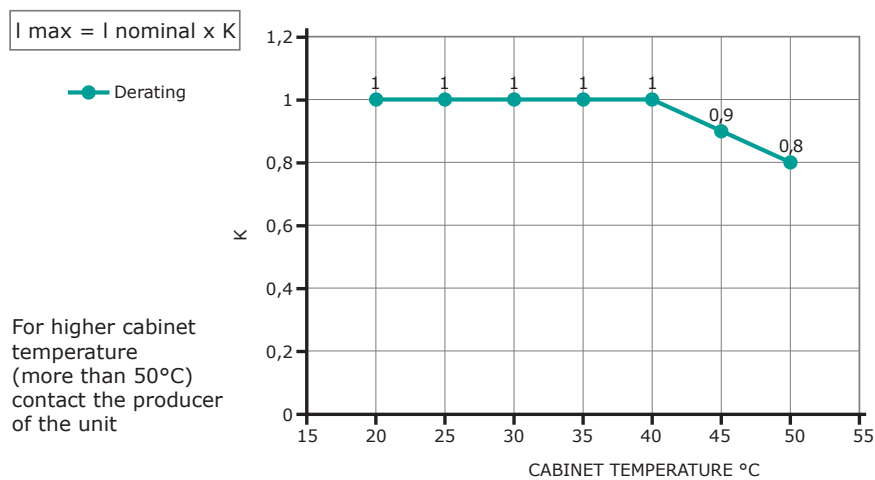

Operation at ambient operating temperature above 40°C not covered by UL®

### 6.7 Calculating flow capacity of the fan

All the thyristor units when are in conduction produces power loss that is dissipated inside cubicle in terms of heating. Due to this fact the internal temperature of cubicle is higher than ambient temperature. To be cooled the thyristor need of fresh air cooling and to do it is normally used a fan mounted on the front door or on the roof of the cabinet.

Procedure to size **Fan air mass flow (V)**: see power loss for each thyristor and fuse mounted indicated in the manual related to the current (Output feature and Internal fuse Chapter).

$V = f * \frac{Q_v}{t_c - t_a}$	<b>Qv</b> = total power losses (w) (thyristor + fuse power loss) <b>ta</b> = ambient temperature (°C) <b>tc</b> = cabinet temperature (°C) <b>V</b> = fan air mass flow (m3/h) <b>f</b> = altitude coefficient (see table on right)	<b>Altitude</b> 0:100 meters <b>f = 3.1</b> m3k/W/h 100:250 meters <b>f = 3.2</b> m3k/W/h 250:500 meters <b>f = 3.3</b> m3k/W/h 500:750 meters <b>f = 3.4</b> m3k/W/h
---------------------------------	--	---



The formulas used are for information only and is not a substitute for a proper thermal rating done by a qualified person.

### 6.8 Wi-Fi Transmitter Module

Models RC\_ \_ \_ \_ \_ \_ \_ \_ \_ \_ \_ \_ \_ \_ \_ \_ with WiFi option contains a Wi-Fi transmitter module, see model label plate for details on which module is installed.

The transmitter module is mounted on the top of the microprocessor board.

The module used can be:

Module FCC ID: 2ADUIESP-12-F 802.11b/g/n 2412-2462 MHz Output Power: • 802.11b: 15,58 dBm (Max.) • 802.11g: 13,72 dBm (Max.) • 802.11n: 12,53 dBm (Max.) Antenna gain: 1.0 dBi PCB antenna 11 channels	OR	Module FCC ID: 2AL3B-ESP-F 802.11b/g/n 2412-2462 MHz Output Power: • 802.11b: 14.0 dBm (Max.) • 802.11g: 12.8 dBm (Max.) • 802.11n: 13.6 dBm (Max.) Antenna gain: 1.0 dBi PCB antenna 11 channels
--	----	---

Unit is assembled from tested components, complete system is tested.

This device complies with Part 15 of the FCC Rules. Operation is subject to the following two conditions:

- (1) this device may not cause harmful interference, and
- (2) this device must accept any interference received, including interference that may cause undesired operation.

**Caution:** no changes or modifications allowed on the equipment not expressly approved by the party responsible for compliance. It could void the user's authority to operate the equipment.

The FCC number is located on the right side of the unit, see sample below:

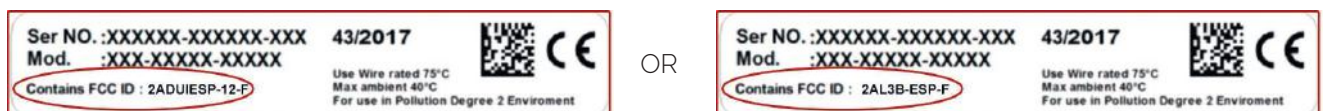

**Note:** This equipment has been tested and found to comply with the limits for a Class A digital device, pursuant to part 15 of the FCC Rules. These limits are designed to provide reasonable protection against harmful interference when the equipment is operated in a commercial environment. This equipment generates, uses, and can radiate radio frequency energy and, if not installed and used in accordance with the instruction manual, may cause harmful interference to radio communications. Operation of this equipment in a residential area is likely to cause harmful interference in which case the user will be required to correct the interference at his own expense.

# 7 Installation

Before to install, make sure that the Thyristor unit have not damages. If the product has a fault, please contact the dealer from which you purchased the product. Verify that the product is the same thing as ordered.

The Thyristor unit must be always mounted in vertical position to improve air cooling on heat-sink.

**Maintain the minimum distances (\*) in vertical and in horizontal as represented, *this area must be free from obstacle (wire, copper bar, plastic channel).***

When more unit has mounted inside the cabinet maintain the air circulation like represented in figure without obstacle for the air flow. Is necessary to install a fan to have better air circulation as calculated previously.

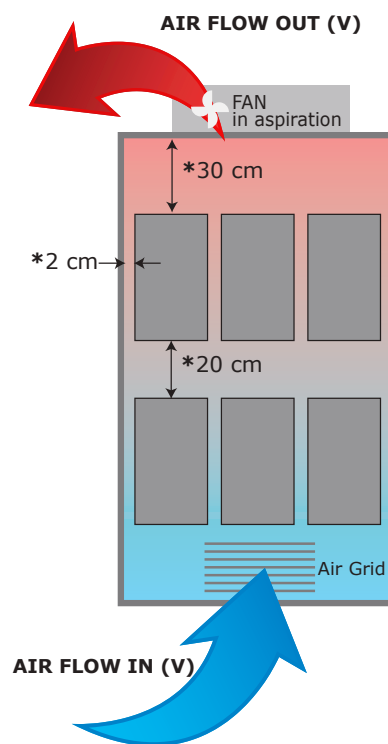

The V Air flow must be equal or more than the value calculated.

If the cabinet fan mounted by the customer have an air flow lower than the correct value the warranty will decay.

### 7.1 Dimensions and Weight

Size: SR20 - 3PH 1100A  
H: 550 mm, W: 717 mm, D: 347 mm  
Weight: 72 Kg

Size: SR23 - 3PH 1400A-1600A-1800A-2100A  
H: 730 mm, W: 717 mm, D: 347 mm  
Weight: 98 Kg

Standard version with IP0

Standard version with IP0



Optional IP20 Protection

Optional IP20 Protection





## 7.2 Fixing holes

1100A

A: 217,5 mm

1400A-1600A-1800A-2100A

A: 267,5 mm

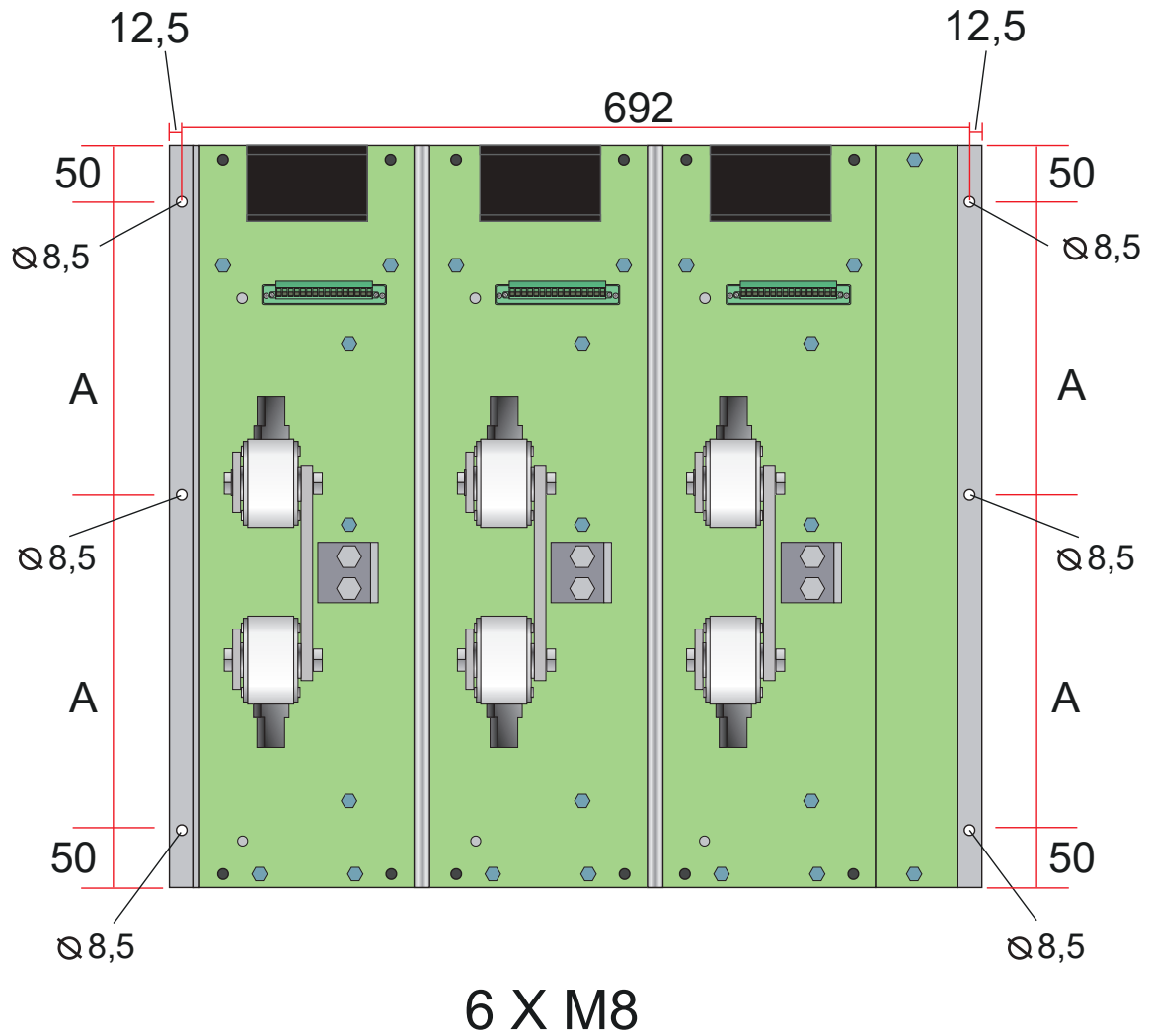

### 7.3. Lifting the unit

- take all necessary safety precautions
- use safety shoes and clothing
- do not keep lifted for longer than strictly necessary



**NO**

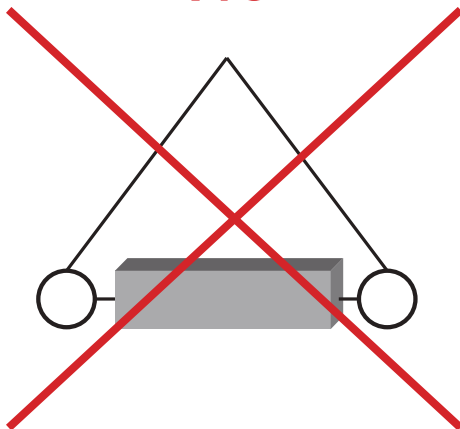

# 8 Wiring instructions

The Thyristor unit could be susceptible to interferences lost by near equipments or by the power supply, for this reason in accord to the fundamental practices rules is opportune take some precautions:

- The coil contactor, the relays and other inductive loads must be equipped with opportune RC filter.
- Use shielded bipolar cables for all the input and output signals.
- The signal cables must not be near and parallel to the power cables.
- Local regulations regarding electrical installation should be rigidly observed.

Use copper cables and wires rated for use at 75°C only.

## 8.1 Terminals Positions



### 8.2 Power Terminals



**Warning:** Before connecting or disconnecting the unit check that power and control cables are isolated from voltage sources.

Terminal	Description
L1	Line Input Phase 1
L2	Line Input Phase 2
L3	Line Input Phase 3
T1	Load Output Phase 1
T2	Load Output Phase 2
T3	Load Output Phase 3

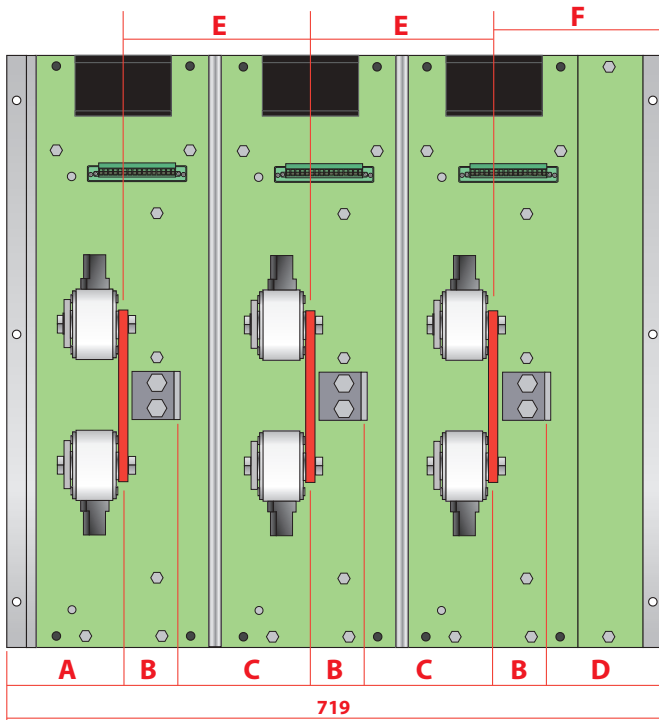
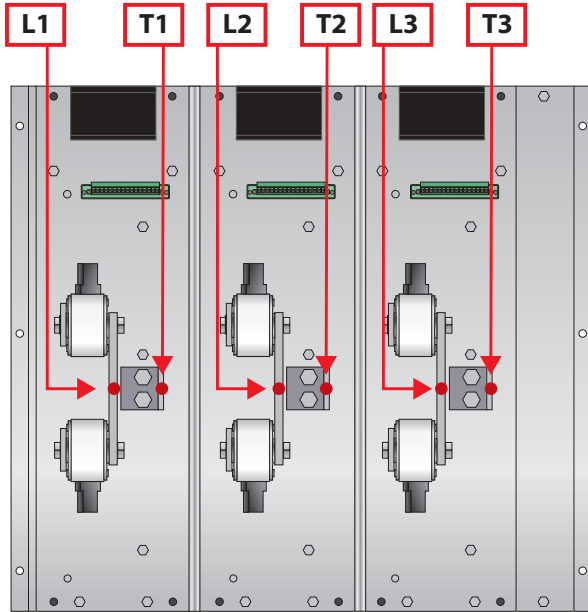

600V	1100A-1400A	A: 114mm	B: 64mm	C: 130mm	D: 153mm	E: 194mm	F: 217mm
	1600A-1800A	A: 116mm	B: 60mm	C: 134mm	D: 155mm	E: 194mm	F: 215mm
	2100A	A: 118mm	B: 56mm	C: 138mm	D: 157mm	E: 194mm	F: 213mm
690V	1100A-1400A	A: 136mm	B: 43mm	C: 152mm	D: 150mm	E: 195mm	F: 193mm
	1600A-1800A	A: 138mm	B: 39mm	C: 156mm	D: 152mm	E: 195mm	F: 191mm
	2100A	A: 140mm	B: 35mm	C: 160mm	D: 154mm	E: 195mm	F: 189mm
	2100A (with new Omega Bar)	A: 110mm	B: 65mm	C: 130mm	D: 154mm	E: 195mm	F: 189mm

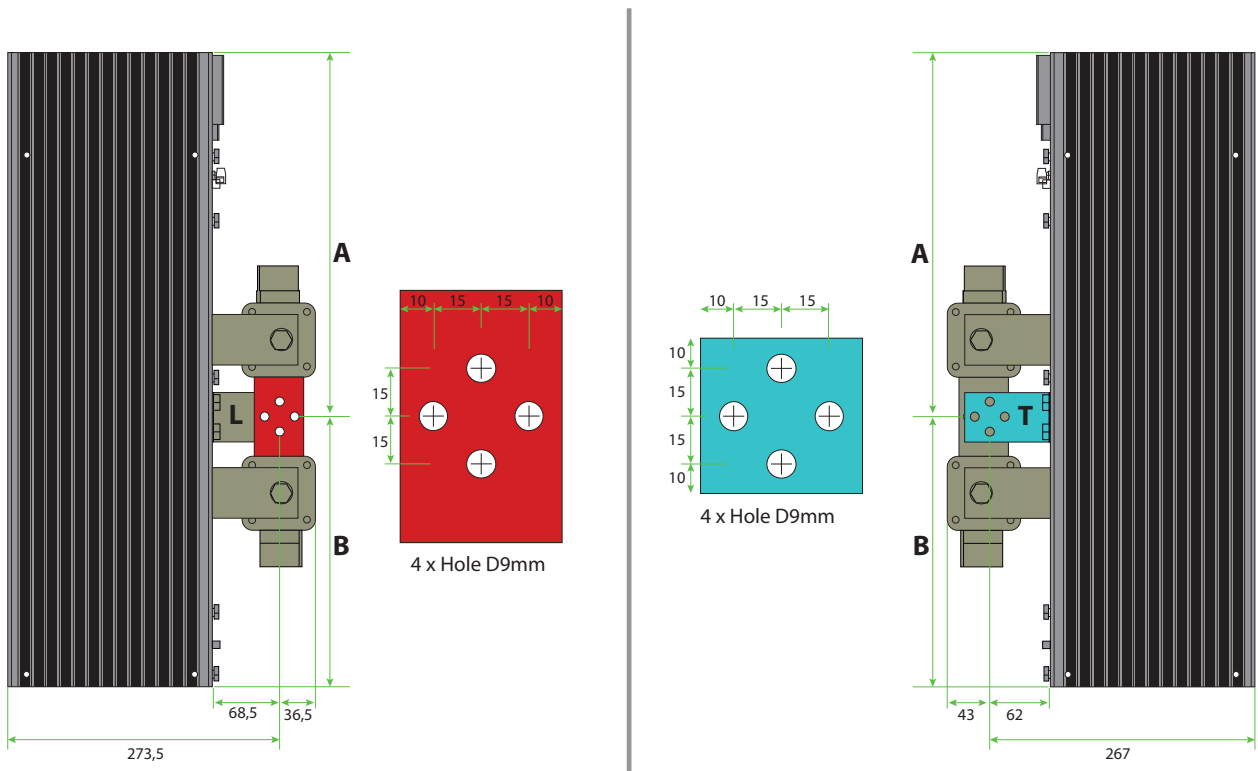

<b>1100A</b>	<b>A:</b> 315mm	<b>B:</b> 220mm
<b>1400A-1600A-1800A-2100A</b>	<b>A:</b> 365mm	<b>B:</b> 270mm

### 8.3 IP20 Cover OPTION

#### 6.3.1 Removing the IP20 cover

For each phase:

- \*1 Unscrew the two bottom M6 screws.
- \*2 Pull out the bottom cover.
- \*3 Unscrew the two upper M6 screws.
- \*4 Pull out the upper cover.

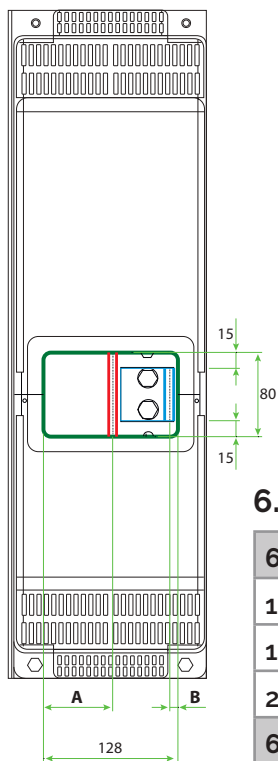
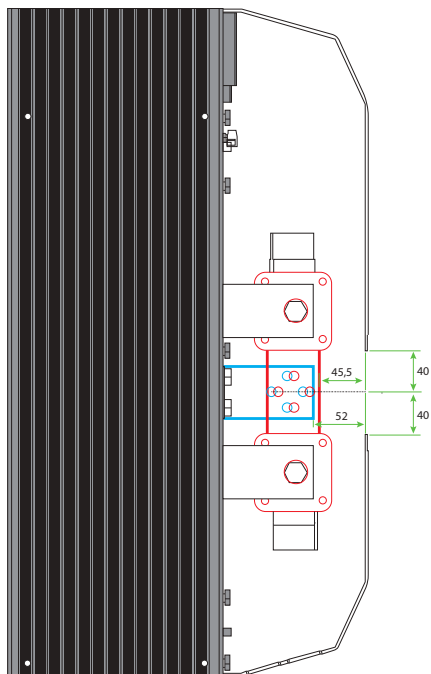
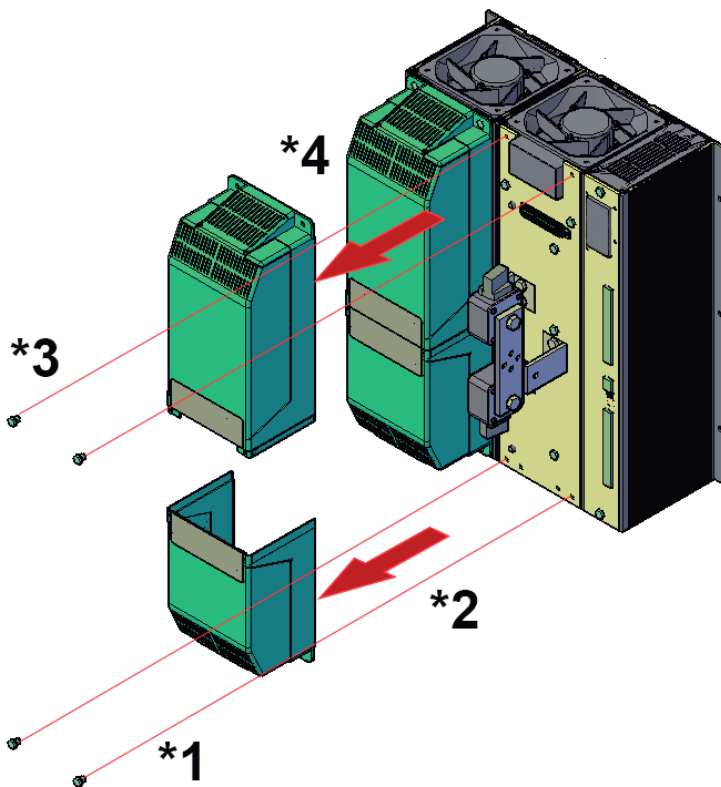

#### 6.3.2 IP20 Cover dimension

600V		
1100A	A: 64mm	B: 10mm
1400A-1600A-1800A	A: 65mm	B: 11mm
2100A	A: 80mm	B: 12mm
690V		
1100A	A: 78mm	B: 10mm
1400A-1600A-1800A	A: 79mm	B: 11mm
2100A	A: 80mm	B: 12mm

### 8.4 Power connection dimensions (suggested)

Current	Supply		Load	
	Bar type	Screw M	Bar type	Screw M
1100A	Bus Bar: 2x 50x6mm	4xM8	Bus Bar: 2x 50x6mm	4xM8
1400A-1600A	Bus Bar: 2x 50x10mm	4xM8	Bus Bar: 2x 50x10mm	4xM8
1800A-2100A	Bus Bar: 3x 50x10mm	4xM8	Bus Bar: 3x 50x10mm	4xM8



Example 2x Bus Bar



Example 3x Bus Bar

#### For UL approval

Current	Connection		Torque Lb/in (Nm)
	Type	Total section of Bus bars	
1100A	Bus Bars with 4xM8 screws	675 mm <sup>2</sup>	265 (30)
1400A - 1600A		1000 mm <sup>2</sup>	
1800A		1500 mm <sup>2</sup>	
2100A		1800 mm <sup>2</sup>	

The directives expressed in the local electrical wiring regulations must be respected in any case.



### 8.5 Cable dimensions (suggested) of Earth and of the Command Terminals

Current	Earth			Command Terminals	
	Cable		Screw	Cable	
	mm <sup>2</sup>	AWG	M	mm <sup>2</sup>	AWG
1100A	95	3/0	M8	0,50	18
1400A	120	4/0	M8	0,50	18
1600A-1800A-2100A	2x95	2x3/0	M8	0,50	18



\* Earth connection

## 8.6 Command Terminals



**Warning:** Before connecting or disconnecting the unit check that power and control cables are isolated from voltage sources.

### 8.6.1 Terminal M5

Terminal	Description
1	NO - Normally Open contact alarm relay output (HB in alarm/GENERAL in alarm)
2	C - Common contact alarm relay output (HB/GENERAL)
3	NC - Normally Close contact alarm relay output (HB in alarm/GENERAL in alarm)
4	+ Analog Input 2 (0-10Vdc/4-20mA Analog Setpoint)
5	DI2 - Enable Digital Input
6	DI1 - Configurable Input / SSR Input
7	RS485 A+
8	RS485 B-
9	Output +10Vdc stabilized 1mA MAX
10	GND
11	- Analog Input 1 (0-10Vdc/4-20mA Analog Setpoint)

Terminal	Description
12	+ Analog Input 1 (0-10Vdc/4-20mA Analog Setpoint)
13	COM I - Common Digital Input
14	Not connected
15	NC - Normally Close contact alarm relay output (FUSE in alarm)
16	C - Common contact alarm relay output (FUSE)
17	NO - Normally Open contact alarm relay output (FUSE in alarm)

### 8.6.2 Terminal M4

Terminal	Description
1	Aux - Voltage Supply for electronic boards 230V (120 as option)
2	Not Connected
3	Aux - Voltage Supply for electronic boards 230V (120 as option)

### 8.6.3 Terminal MX 1-2

Terminal	Description
1	Internal Connection (G+)
2	Internal Connection (K+)
3	Internal Connection (G-)
4	Internal Connection (K-)
5	Internal Connection (Current Transformer)
6	Internal Connection (Current Transformer)
7	Internal Connection (Fuse fault Switch)
8	Internal Connection (Fuse fault Switch)
9	Internal Connection (Fan fault Switch)
10	Internal Connection (Fan fault Switch)
11	Internal Connection (PT1 Thermal Switch)
12	Internal Connection (PT1 Thermal Switch)
13	PT2 Thermal Switch
14	PT2 Thermal Switch
15	Fan supply voltage (230V standard – 115 option)
16	Fan supply voltage (230V standard – 115 option)

### 8.6.4 Terminal M6 (Option)

Terminal	Description
1	Auxiliary +24Vdc 500mA Input backup power supply for communication
2	GND (0V)
3	Not connected
4	Retransmission Output 0-10Vdc 4-20mA

### 8.7 Fan Supply For Each Phase (MX1 – MX2 - MX3)

Terminal	Description
15	Fan supply voltage (230V standard – 115 option)
16	Fan supply voltage (230V standard – 115 option)

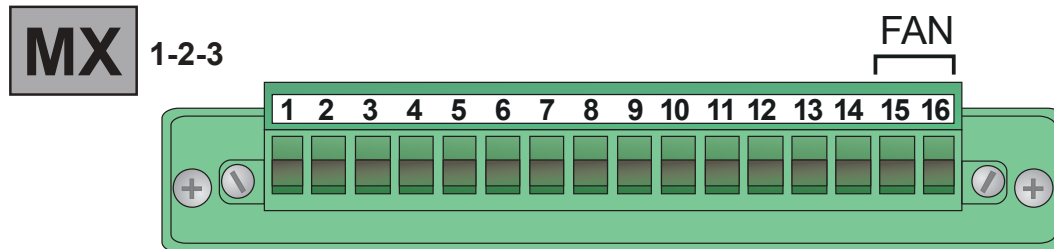

### 8.8 Thermal Switch For Each Phase (MX1 – MX2 - MX3)

Terminal	Description
13	PT2 Thermal Switch
14	PT2 Thermal Switch

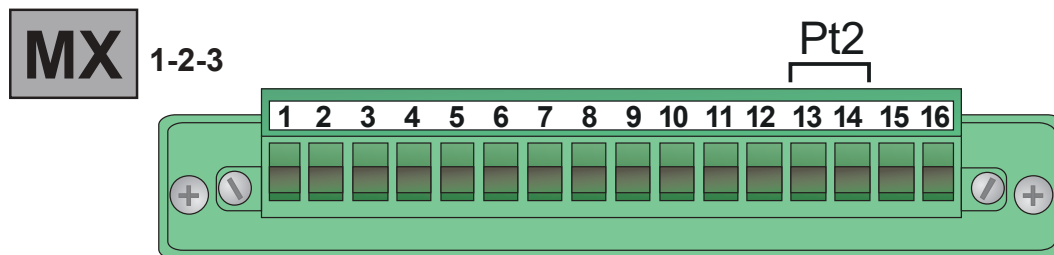

### 8.9 Schematic



**Caution:** this procedure must be performed only by qualified persons.

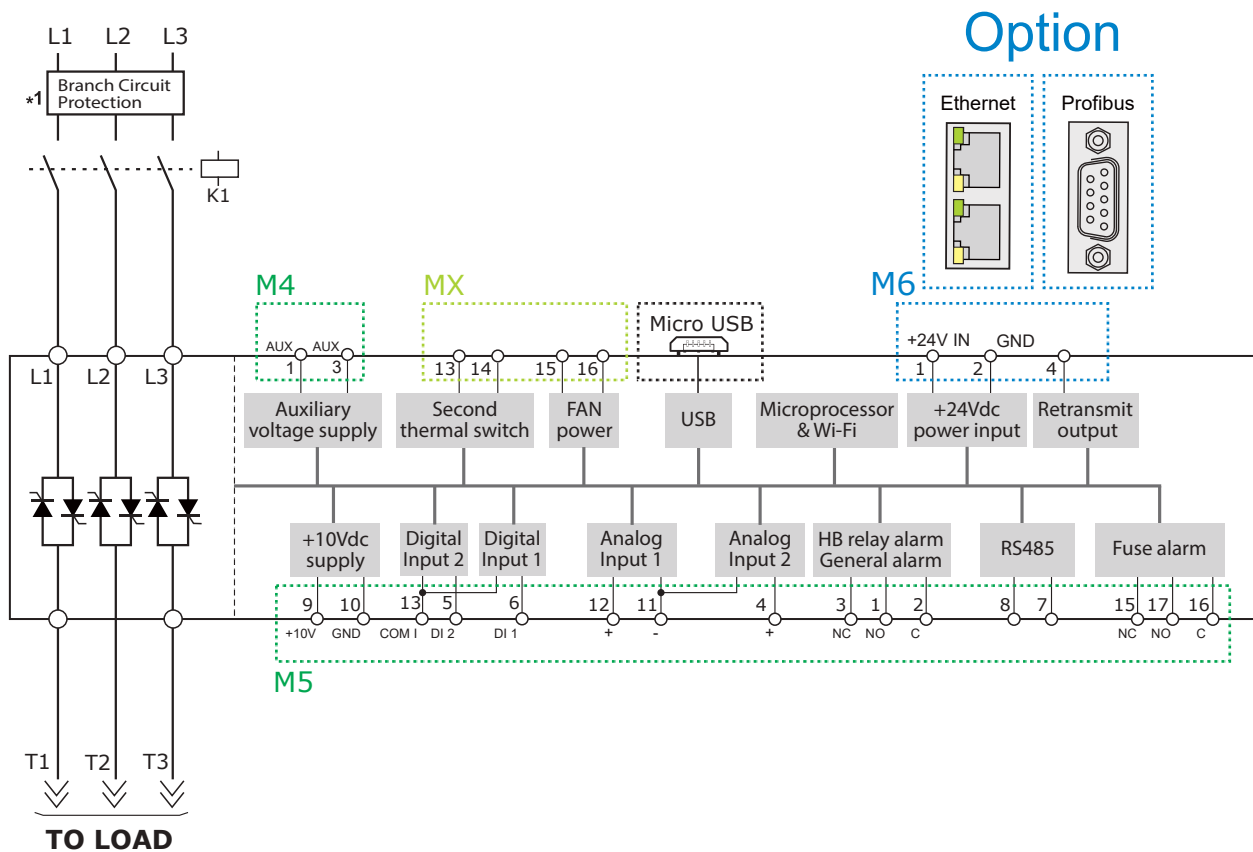



**Caution:** this procedure must be performed only by qualified persons.



Indicative connection diagrams. Refer to local regulations for proper system protection.

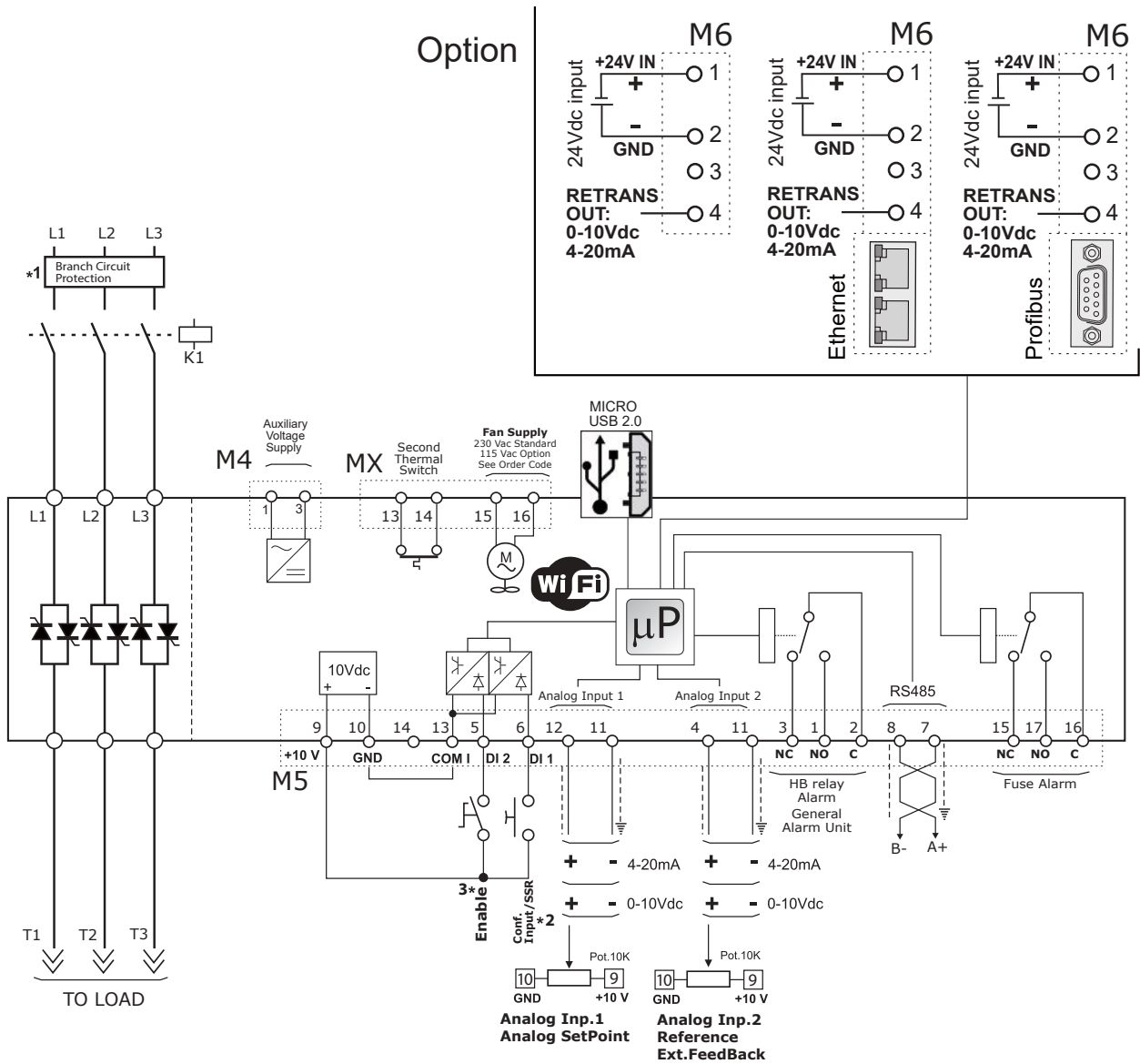

**NOTE:**

- \*1 The user installation must be protecting by electromagnetic circuit breaker or by fuse isolator. The Fuse must be branch circuit protection. For UL any listed UL branch circuit fuse would be acceptable as an external fuse, following national electric code guide for resistive heating of 125% load current rating to protect external wires.
- \*2 For SSR input connection follow next page schematic.
- \*3 **IMPORTANT! Starting Strategy (Enable):**
  - 1: Feed the unit with L1-L2-L3 power voltage supply
  - 2: Feed the auxiliary supply
  - 3: Close the Enable contact to start with the regulation

Load Type

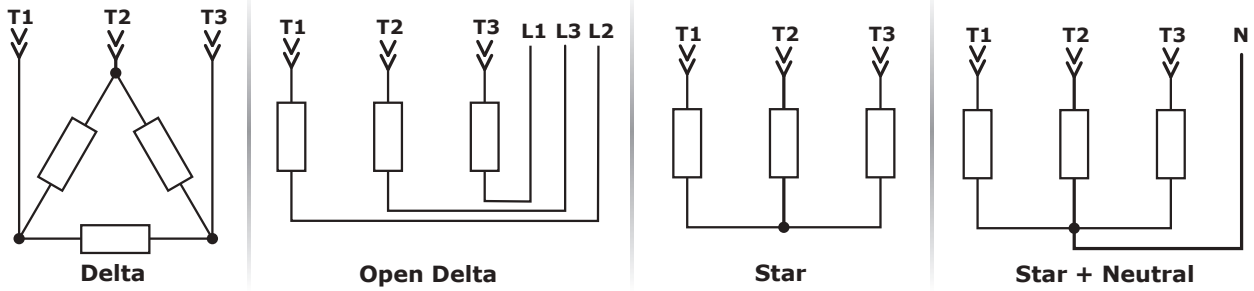

8.9.1 SSR Control Input schematic

For SSR input use follow the schematic below and configure Digital Input 1 as Fast Enable.

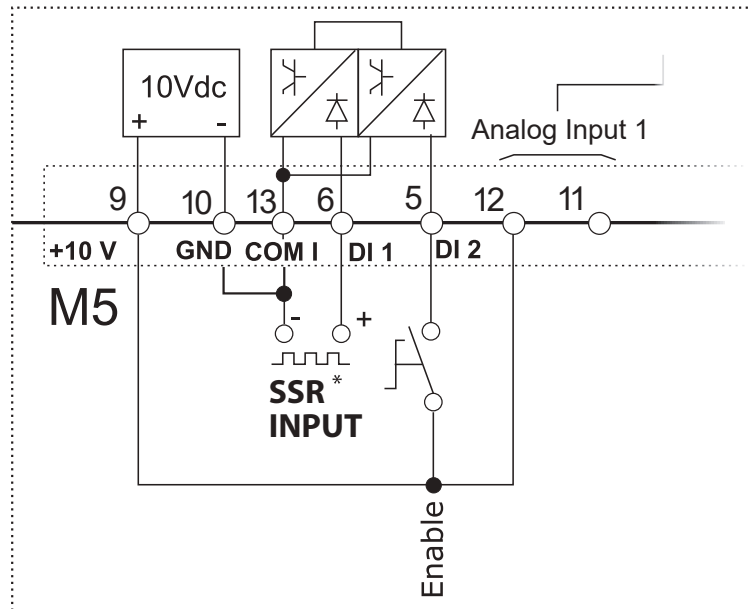

\* SSR Input: 4÷30Vdc 5mA Max (ON ≥4Vdc / OFF <1Vdc)  
Frequency 3Hz Max - On time min. 100 ms



### 8.10 Connection Diagram for 3 phases (control on 3 phases)

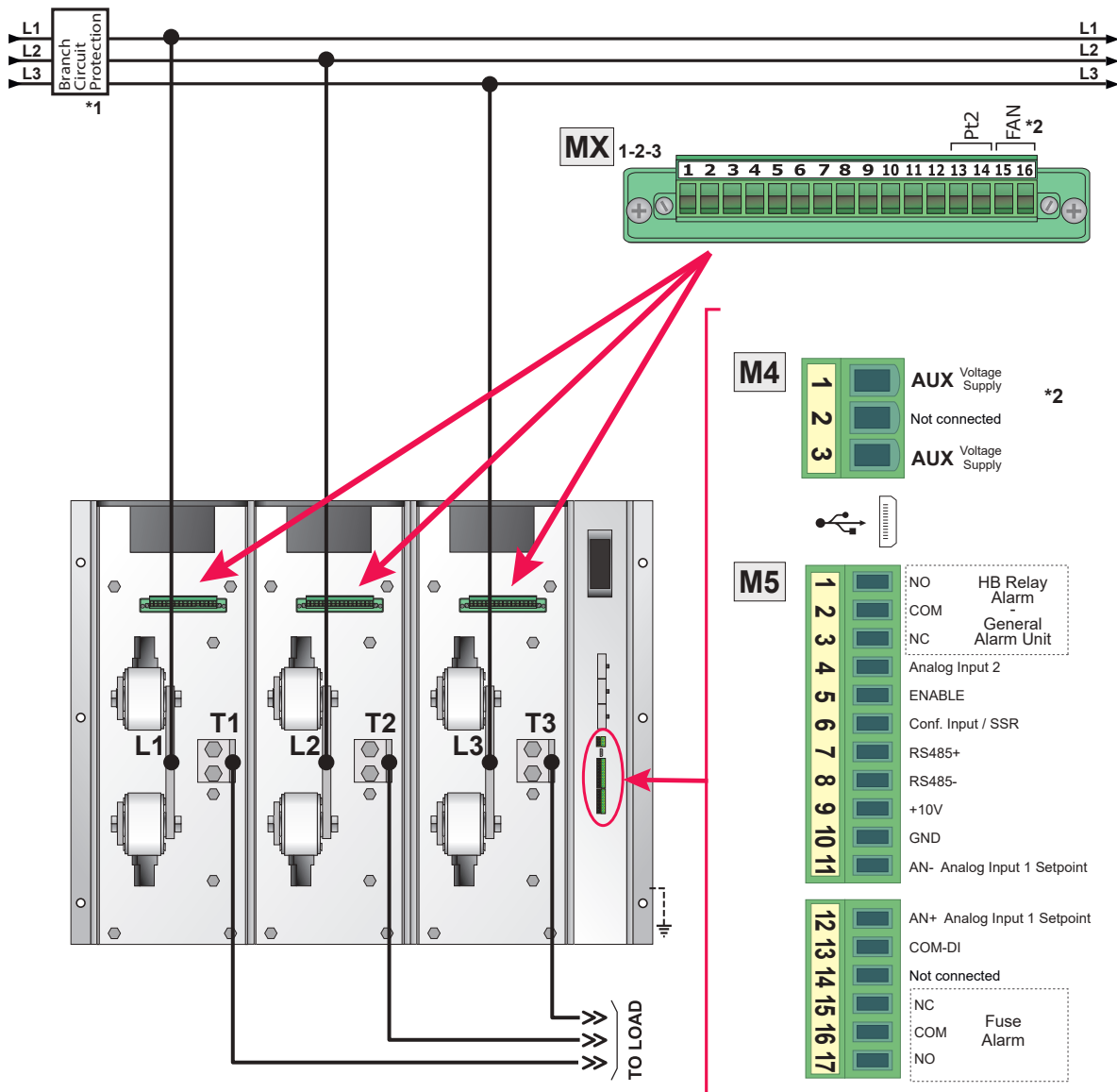

- \*1 The user installation must be protecting by electromagnetic circuit breaker or by fuse isolator. The Fuse must be branch circuit protection. For UL any listed UL branch circuit fuse would be acceptable as an external fuse, following national electric code guide for resistive heating of 125% load current rating to protect external wires.
- \*2 For the voltage value see Order Code (230V-120V)

# 9 Control Panel

The Control Panel is placed on the front of the thyristor unit, on his display you can visualize the alarms, the input and output signals and all the configuration parameters.

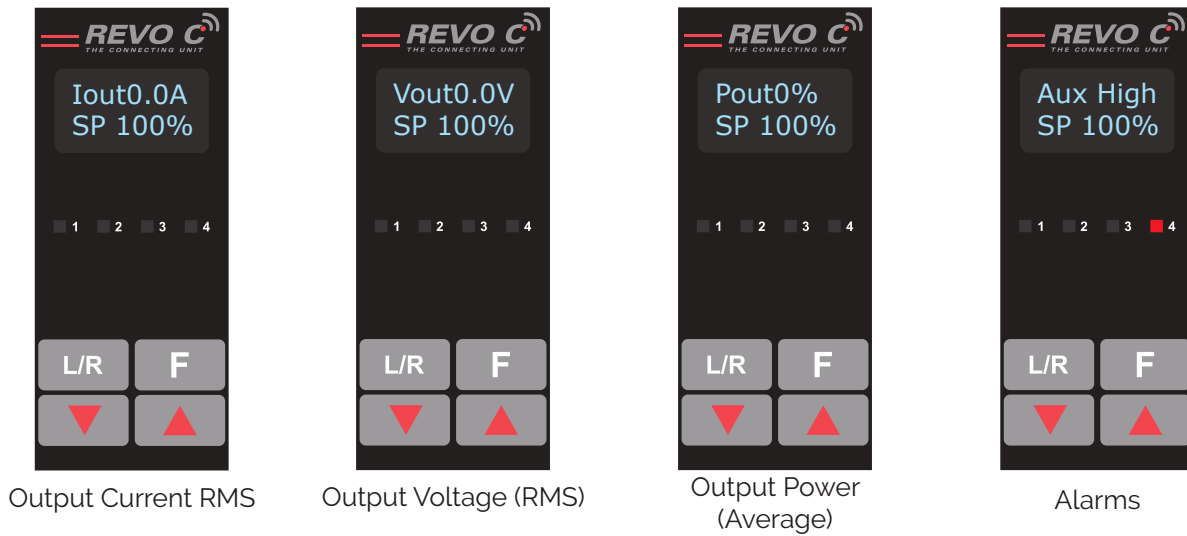

On the home page the keys are used as follows:

Press...		to...
<b>F</b>	Function	Scroll through the parameters on the home page
<b>L/R</b>	Local/Remote	Switch between local and remote set point for power demand
<b>▼</b>	Up	Increment power demand set point when set to local
<b>▲</b>	Down	Decrement power demand set point when set to local
<b>F</b> + <b>L/R</b>		Press and hold for about two seconds to access the menus

To view the status parameters:

- Press Function **F** once to advance from one parameter to the next

To set the set point locally:

- Press Local/Remote **L/R** (Note: indicator 1 flashes steadily when set point is set locally)
- Use Down **▼** and/or Up **▲** to set the local set point.

### 9.1 Menu navigation

The menus are accessible using the control panel keypad and display.

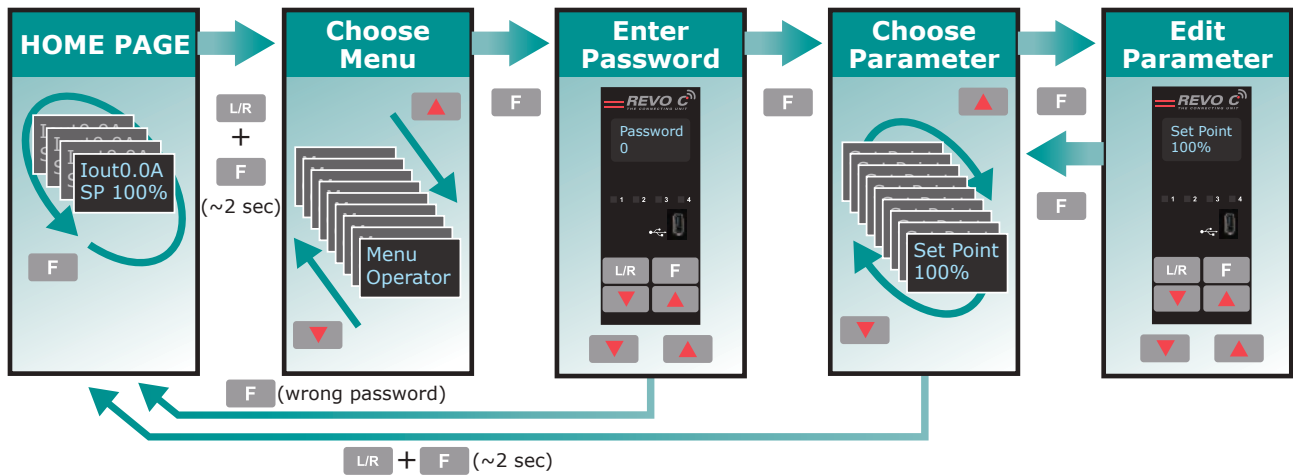

**To access a menu and edit a setting:**

1. Press and hold Local/Remote and Function together **L/R + F** until the upper display flashes Menu.
2. Press Up **▲** to choose the menu. (Press down **▼** if you overshoot the menu you want).
3. Press function **F** to advance to the password prompt.
4. Use up **▲** and/or down **▼** to set the password (see the table).
5. Press function **F** to enter the password and advance to the first parameter of the menu.
6. Press Up **▲** to advance to the next parameter and repeat to reach the desired parameter.
7. Press function **F** to start editing the parameter. The parameter name flashes in the upper display.
8. Use Up **▲** and/or down **▼** to edit the parameter setting.
9. Press function **F** to enter the new setting. The parameter name stops flashing.
10. Press and hold local/remote and function together **L/R + F** for about two seconds to exit the menus.

Menu	Password	Parameter used to...
Operator	0	View measured values and basic settings including current, voltage and set point
Setup	2	Configure the power controller for the load
Adv Setup	10	Configure the operation and performance of the power controller in the application
Hardware	5	Configure the functions of the analog and digital inputs and outputs, and the re-transmission parameters
Comm	3	Configure field bus communicating parameters
Monitoring	0	View measured and calculated values and other read-only parameters

### 9.2 Control Panel Led

The four indicators on the control panel show the general state of the power controller.

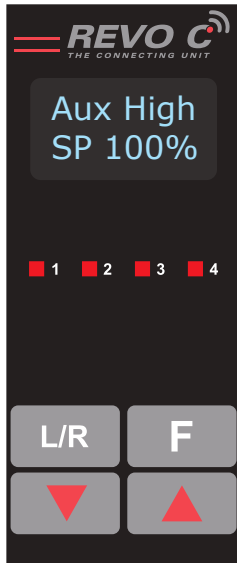

1	Local/Remote	Flashing	Power output set locally or via communications
		Off	Power output set remotely (via analog input)
2	Enable	On	Output enabled
		Off	Output disabled
3	Communications	Flashing	Active communications
4	Alarm	Flashing	Active alarm
		Off	No alarm

### 9.3 Displayed alarms

Alarm or	Message	Description
HeatBrk		Heater Break
Aux High		Aux voltage too high
Aux Low		Aux voltage too low
	BakeOut	Heater Bakeout function active
ComError		Communication Watchdog error
Line Loss		Line power not detected
I Limit		Output limited by current limit feature
SD Error		SD card error
SHRT		Short Circuit on SCR
SCR Temp		Thermal Switch over temperature
Line Loss		L1 and L2 not detected
Phase Loss		L1 or L2 or L3 not detected
FAN		Indicate that a fan is not working properly or not supplied
FUSES		Indicate if a fuse is burned

### 9.4 Parameter list

This chapter describes the parameter on the menus accessed via the control panel and Configurator software. To learn how to access the menus described below see "Menu navigation" chapter.

#### Menu Listing

The table below lists the parameters found on each menu. See the following pages for descriptions and other details of each parameter.

Operator	Setup	Advanced Setup	Hardware	Communication	Monitoring
Set Point	Out Scale	Firing Type	Analog in 1	Port 1 Baud	FUSES
Volts Out	I Limit SP	Min Cycle	Analog in 2	Port 1 Addr	Dig in 1
Current	Nom Line V	Soft Start	An2 Funct	Port 2 Baud	Dig in 2
Power	Nominal I	Start Ramp	DI1 Functn	Watchdog	FAN
Volts In	Soft Start	Delay	DI2 Functn	WD Reset	Enable
Frequency	SP Select	Cycle Time	Alm Out Fn	Wi-Fi Addr	SP Source
Pwr Factor		Feedback	IL SP Src	Field Name	Analog In1
Load Q		Pb Power	Retransmit	Unit Name	Analog In2
I Limit SP		Ti Power	Rtx Scale	Port 2 Addr	SW Ver
Out Scale		Pb Current	Rtx Type	Port 2	SW Rel
Nom Line V		Ti Current	Start Disp	Wi-Fi	Unit Type
Nominal I		HB Sense			Max Voltage
		HB Delay			Max Current
		Logging			Aux Voltage
		Log Period			Serial No.
		Htr Bake			SCR Temp

Read/write     Read only

### 9.4.1 Operator Menu

This section describes each item on the operator menu. Use this menu to view the measured values and basic settings of the power controller. **The password to access this menu is 0.**

Parameter Name	Description	Range	Unit	Modbus Address	Par. Type
Set Point	View the set point	0 to 100	%	15	Read Only
Volts Out	Indicates the average (RMS) voltage of all phases	0 to 1023	V	10	Read Only
Current	Indicates the average (RMS) current of all phases	0 to 1023	V	11	Read Only
Power	Indicates the average (RMS) power output	0 to 100	%	12	Read Only
Volts In	Indicates the average (RMS) voltage input	0 to 65535	V	47	Read Only
Frequency	Indicates frequency of the power input	0 to 655.35	Hz	9	Read Only
Pwr Factor	Indicates power factor of the output power	0 to 1000		102	Read Only
Load $\Omega$	Indicates the resistance of the load	0 to 655.35	$\Omega$	46	Read Only
I Limit SP	Indicates the maximum percent of the nominal current that the power control allows. This parameter indicates RMS current by default. When parameter 52 is set to 1, this parameter indicates peak current	0 to 100	%	17	Read Only
Out Scale	Indicates the percentage by which the power demand set point is scaled	0 to 100.0	%	16	Read Only
Nom Line V	Indicates the user-set, nominal value for the line voltage input	0 to 1023	V	37	Read Only
Nominal I	Indicates the user-set, nominal load current	0 to 999.9	A	38	Read Only

### 9.4.2 Setup Menu

This section describes each item on the setup menu. Use this menu to configure the power controller for the load. **The password to access this menu is 2.**

Parameter Name	Description	Range	Unit	Modbus Address	Par. Type
<b>Out Scale</b>	Set the percentage by which the set point is scaled. For example, if a 0 to 10V analog input providing the set point is 5V and output scaling is 80% then the effective set point is 40%	0 to 100.0	%	16	Read Write

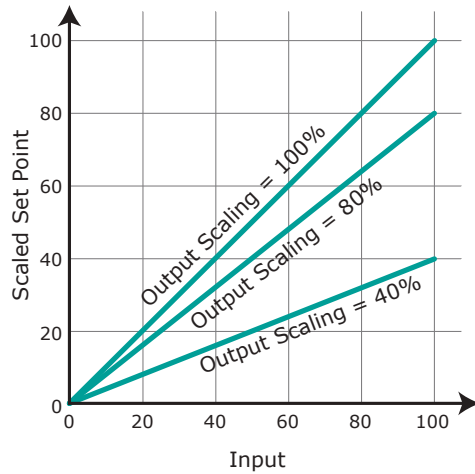

Parameter Name	Description	Default	Range	Unit	Modbus Address	Par. Type
<b>I Limit SP</b>	Set the maximum percent of the nominal current that the power control allows. This parameter indicates RMS current by default. When parameter 52 is set to 1, this parameter indicates peak current	100%	0 to 100.0	%	17	Read Write
<b>Nom Line V</b>	Set the nominal value for the line voltage input	220V	0 to 1023	V	37	Read Write
<b>Nominal I</b>	Set the nominal load current	Maximum current	0 to 6000,0	A	38	Read Write
<b>Soft Start</b>	Set the duration of the soft start in increment of 100mSec. The power controller ramps set to point changes over the time set here. For more information see "Firing type" page: Soft Start with Burst Firing and Soft Start with Phase Angle	100 (10 sec)	0 to 255 (0 to 25.5 sec)		23	Read Write
<b>SP select</b>	Choose the source for the remote set point	0			61	Read Write

Option	Value
<b>Analog In 1</b>	0
<b>Analog In 2</b>	1

### 9.4.3 Advanced Setup Menu

This section describes each item on the advanced setup menu. Use this menu to configure the power switching, closed loop control of power and adjustable settings for data logging and heater bakeout. **The password to access this menu is 10.**

Parameter Name	Description	Default	Modbus Address	Par. Type
<b>Firing Type</b>	Choose the firing mode	3	18	Read Write

Option	Value
<b>Zero Cross</b>	1
<b>Single Cyc</b>	2
<b>Burst fire</b>	3
<b>Ph Angle</b>	4
<b>Burst StrtR</b>	19
<b>PA SoftS</b>	20
<b>Delay Trig</b>	35
<b>DEFAULT: Burst Fire</b>	3

Parameter Name	Description	Default	Range	Unit	Modbus Address	Par. Type
<b>Min Cycles</b>	Set the minimum number of On cycles and off cycles for burst firing.	8	0 to 999.9	n°	20	Read Write
<b>Soft Start</b>	Set the duration of the soft start in increment of 100mSec. The power controller ramps set to point changes over the time set here. For more information see "Firing type" page: Soft Start with Burst Firing and Soft Start with Phase Angle	100 (10 sec)	0 to 255 (0 to 25.5 sec)		23	Read Write
<b>Start Ramp</b>	Set the number of half cycles over which the power ramps each time the output turns on.	0	0 to 1024	n°	25	Read Write
<b>Delay</b>	Set the firing delay degrees. Applies to burst firing with delay trigger	1	1 to 255	°	22	Read Write
<b>Cycle time</b>	Set the duration of one on-off cycle in increments of 50mSec. Applies to zero crossing	60 (3 sec)	0 to 255 (0 to 12.75 sec)		24	Read Write



Parameter Name	Description	Default	Range	Unit	Modbus Address	Par. Type
<b>Feedback</b>	Choose the feed-back type	1			19	Read Write

Option	Description	Value
<b>V<sup>2</sup></b>	Voltage squared	0
<b>None</b>	No feed-back	1
<b>I<sup>2</sup></b>	Current squared	2
<b>Voltage</b>	Voltage	32
<b>Current</b>	Current	64
<b>Power</b>	Power	128
<b>External</b>	External signal via analog input 2	256
<b>DEFAULT:</b> None		1

Parameter Name	Description	Default	Range	Unit	Modbus Address	Par. Type
<b>Pb Power</b>	Set the gain for the main loop. A larger value yields a larger adjustment for a given deviation	10%	0 to 255	%	26	Read Write
<b>Ti Power</b>	Set how aggressively the integral part of the control algorithm acts. A larger settings yields a larger adjustment for a given deviation over a given time	50	0 to 255		27	Read Write
<b>Pb Current</b>	Set the gain for the current loop. A larger value yields a larger adjustment for a given deviation	10%	0 to 255	%	63	Read Write
<b>Ti Current</b>	Set how aggressively the integral acts in the current loop. A larger settings yields a larger adjustment for a given deviation over a given time	50	0 to 255		64	Read Write
<b>HB Sense</b>	Set the threshold of resistance that activates the Heater Break alarm. This setting is in percentage of the nominal load resistance	100%	0 to 100.0	%	29	Read Write

Parameter Name	Description	Default	Range	Unit	Modbus Address	Par. Type
<b>HB Delay</b>	Set a delay between when the resistance drops below the value set for a heater break sensitivity and when the heater break alarm is indicated. This set increments of 50mSec	50 (2,5 sec)	0 to 255 (0 to 12,75 sec)		28	Read Write
<b>Logging</b>	Enable or disable data logging on the internal SD card	0			139	Read Write

Option	Value
<b>Off</b>	0
<b>On</b>	1
<b>DEFAULT: Off</b>	0

Parameter Name	Description	Default	Range	Unit	Modbus Address	Par. Type
<b>Log Period</b>	Set how often data is logged	5 sec	0 to 255	sec	70	Read Write
<b>Htr Bake</b>	Enable or disable the heater bakeout feature	0			140	Read Write

Option	Value
<b>Off</b>	0
<b>On</b>	1
<b>DEFAULT: Off</b>	0

Parameter Name	Description	Default	Modbus Address	Par. Type
<b>Load Type</b>	3 Phase Load connection type	0	156	Read Write

Option	Value
<b>4Star</b>	1
<b>3Star/Delta</b>	0

### 9.4.4 Hardware Menu

This section describes each item on the hardware menu. Use this menu to configure how the inputs and outputs are used in the application. **The password to access this menu is 5.**

Parameter Name	Description	Default	Modbus Address	Par. Type
<b>Analog In 1</b>	Choose the type of signal to be measured by analog input 1	1	44	Read Write

Option	Description	Value
<b>0-10V</b>	0 to 10 Vdc or 10,000Ω	1
<b>4-20mA</b>	4 to 20 mAdc	2
<b>0-20mA</b>	0 to 20 mAdc	3
<b>DEFAULT: 0-10V</b>		1

Parameter Name	Description	Default	Modbus Address	Par. Type
<b>Analog In 2</b>	Choose the type of signal to be measured by analog input 2	1	105	Read Write

Option	Description	Value
<b>0-10V</b>	0 to 10 Vdc or 10,000Ω	1
<b>4-20mA</b>	4 to 20 mAdc	2
<b>0-20mA</b>	0 to 20 mAdc	3
<b>DEFAULT: 0-10V / 10k Pot</b>		1

Parameter Name	Description	Default	Modbus Address	Par. Type
<b>An2 Funct</b>	Choose how the signal measured by analog input 2 is used	0	116	Read Write

Option	Description	Value
<b>I Limit SP</b>	Current Limit Set point	0
<b>Feedback</b>	External feed-back	1
<b>Set Point</b>	Power Demand set point	2
<b>DEFAULT: I Limit</b>		0

Parameter Name	Description	Default	Modbus Address	Par. Type
<b>D11 Functn</b>	Choose how the signal detected by digital input 1 is used	2	32	Read Write

Option	Description	Value
<b>Enable</b>	Enable power output	0
<b>V Feedback</b>	Use voltage feed-back when on	2
<b>Local / Rmt</b>	Local when on / Remote when off	3
<b>Ph Angle</b>	Use phase angle firing when on	4
<b>SP AI1/AI2</b>	Select remote set point source: analog input 1 when off or analog input 2 when on	5
<b>Logging</b>	Enable logging	6
<b>Htr Bake</b>	Enable heater bakeout	7
<b>FastEn</b>	Fast Enable*	8
Alarm Reset		9
<b>DEFAULT:</b> Voltage Feed-back		2

\* **SSR Input:** 4÷30Vdc 5mA Max (ON ≥4Vdc / OFF <1Vdc) Frequency 3Hz Max - On time min. 100 ms  
 When the Fast Enable input is enabled, Phase Angle firing is automatically selected.

Parameter Name	Description	Default	Modbus Address	Par. Type
<b>D12 Functn</b>	Choose how the signal detected by digital input 2 is used	0	33	Read Write

Option	Description	Value
<b>Enable</b>	Enable power output	0
<b>V Feedback</b>	Use voltage feed-back when on	2
<b>Local / Rmt</b>	Local when on / Remote when off	3
<b>Ph Angle</b>	Use phase angle firing when on	4
<b>SP AI1/AI2</b>	Select remote set point source: analog input 1 when off or analog input 2 when on	5
<b>Logging</b>	Enable logging	6
<b>Htr Bake</b>	Enable heater bakeout	7
<b>FastEn</b>	Fast Enable*	8
Alarm Reset		9
<b>DEFAULT:</b> Enable		0

\* **SSR Input:** 4÷30Vdc 5mA Max (ON ≥4Vdc / OFF <1Vdc) Frequency 3Hz Max - On time min. 100 ms  
 When the Fast Enable input is enabled, Phase Angle firing is automatically selected.

Parameter Name	Description	Default	Modbus Address	Par. Type
<b>Alm Out Fn</b>	<p>Choose for which conditions the digital output indicates alarm. The output always indicate an alarm when the heat sink is over temperature. The digital output is energized for normal operating condition and de-energized when the power controller is off or when there is an alarm.</p> <p><b>Note!:</b> The power controller monitors for heater break or short circuit condition only when included in the option selected for Alarm Output Function</p>	1	34	Read Write

Option	Description	Bit
Heater Break	Heater Break	0
Short Circuit	Short circuit	1
Current Limit	Current Limit	2
Therm	SCR is over temperature	3
Communication	Communication watchdog error	4
FAN	Indicate that a fan is not working properly or not supplied	7
<b>DEFAULT</b>		None

Alarm Bitwise is allowed

Parameter Name	Description	Default	Modbus Address	Par. Type
<b>IL SP Src</b>	Choose how the current limit is set	16	14,bit 4	Read Write

Option	Description	Value
<b>Local / Comms</b>	Set point set via keypad or communication	16
<b>Analog In 2</b>	Set point set via analog input	0
<b>DEFAULT:</b> local		16

Parameter Name	Description	Default	Modbus Address	Par. Type
<b>Retransmit</b>	Choose which parameter is retransmitted by the analog output	12	68	Read Write

Option	Description	Value
<b>Set Point</b>	Set point	15
<b>Volts Out</b>	RMS voltage output	10
<b>Power</b>	Average output power	12
<b>Current</b>	RMS current output	11
<b>None</b>	Do not retransmit value	0
<b>DEFAULT:</b> Power		12

Parameter Name	Description	Default	Range	Unit	Modbus Address	Par. Type
<b>Rtx Scale</b>	Set the value of retransmitted parameter to be represented by the full scale of the analog output. See the table below	0	0 to 9999		124	Read Write

Retransmit	Recommended Retransmission Scaling	Resulting Signal (4 to 20 mADC)	Resulting Signal (0 to 20 mADC)	Resulting Signal (0 to 10 VDC)	Max Value
Set Point	100	4mADC = 0% 20mADC = 100%	0mADC = 0% 20mADC = 100%	0VDC = 0% 10VDC = 100%	100.0
V Output	<b>xV</b> where <b>x</b> is the Nominal Line Voltage	4mADC = 0V 20mADC = xV	0mADC = 0V 20mADC = xV	0VDC = 0V 10VDC = xV	999.9
I Output	<b>xA</b> where <b>x</b> is the Nominal Line Current	4mADC = 0A 20mADC = xA	0mADC = 0A 20mADC = xA	0VDC = 0A 10VDC = xA	999.9
Power	100	4mADC = 0% 20mADC = 100%	0mADC = 0% 20mADC = 100%	0VDC = 0% 10VDC = 100%	100

Parameter Name	Description	Default	Modbus Address	Par. Type
<b>Rtx Type</b>	Choose type of signal for the retransmission output	1	69	Read Write

Option	Value
<b>4-20mA</b>	0
<b>0-10V</b>	1
<b>0-20mA</b>	2
<b>DEFAULT: 0-10V</b>	1

Parameter Name	Description	Default	Modbus Address	Par. Type
<b>Start Disp</b>	Choose which parameter is displayed on the home page at power-up	1	60	Read Write

Option	Value
<b>Current</b>	0
<b>Volts Out</b>	1
<b>Power</b>	2
<b>DEFAULT: Voltage</b>	1

### 9.4.5 Communication Menu

This section describes each item on the communication menu. Use this menu to configure the communication options. **The password to access this menu is 3.**

Parameter Name	Description	Default	Modbus Address	Par. Type
<b>Port 1 Baud</b>	Choose the baud rate for the primary serial port	2	30	Read Write

Option	Value
<b>9600</b>	0
<b>19.2K</b>	1
<b>38.4K</b>	2
<b>115.2K</b>	3
<b>DEFAULT: 38.4K</b>	2

Parameter Name	Description	Default	Range	Unit	Modbus Address	Par. Type
<b>Port 1 Addr</b>	Set the address for the primary serial port	1	0 to 255		31	Read Write
<b>Port 2 Baud</b>	Choose the baud rate for the primary serial port	2			45	Read Write

Option	Value
<b>9600</b>	0
<b>19.2K</b>	1
<b>38.4K</b>	2
<b>115.2K</b>	3
<b>DEFAULT: 38.4K</b>	2

Parameter Name	Description	Default	Modbus Address	Par. Type
<b>Watchdog</b>	Enable or disable the watchdog on the primary serial port	0	142	Read Write

Option	Value
<b>Off</b>	0
<b>On</b>	1
<b>DEFAULT: Off</b>	0



Parameter Name	Description	Default	Range	Unit	Modbus Address	Par. Type
<b>WD Reset</b>	Set the amount of time to wait for a communication message before triggering the watchdog error	5	0 to 255	Sec	143	Read Write
<b>Wi-Fi Addr</b>	Indicate the IP address of the WiFi connection in the power controller		0 to 255		94-95 96-97	Read Only
<b>Field Name</b>	Only with Profinet option		0 to 255		79-80 81-82	Read Only
<b>Unit Name</b>	Indicate the name of the unit		max 16 characters		83-84 85-86 87-88 89-90	Read Only
<b>Port 2 Addr</b>	Set the address for the secondary serial port or the Profibus Address	0	0 to 1024		122	Read Write
<b>Port 2</b>	Indicates the type of secondary communication port				119	Read Write

Option	Description	Value
<b>Disabled</b>	No secondary communication port	0
<b>Ethernet</b>	Modbus TCP or ProfiNet	1
<b>RS-485</b>	RS-485	2

Parameter Name	Description	Default	Modbus Address	Par. Type
<b>Wi-Fi</b>	Enable or disable WiFi communication	0	120	Read Write

Option	Value
<b>Off</b>	0
<b>On</b>	1
<b>DEFAULT: Off</b>	0



**Caution:** If Bus port is not connected or in error, all writable parameters are set to 0 value

### 9.4.6 Monitoring Menu

This section describes each item on the monitoring menu. Use this menu to view the states of digital input, values of analog input and information about the power controller such as serial number and software version.

The password to access this menu is 0.

Parameter Name	Description	Modbus Address	Par. Type
<b>FUSES</b>	Indicate the state of the fuses	13 bit7	Read Only

Option	Value
Off	0
On	1

Parameter Name	Description	Modbus Address	Par. Type
<b>Dig In 1</b>	Indicate the state of the signal to digital input 1	13 bit8	Read Only

Option	Value
Off	0
On	1

Parameter Name	Description	Modbus Address	Par. Type
<b>Dig In 2</b>	Indicate the state of the signal to digital input 2	13 bit9	Read Only

Option	Value
Off	0
On	1

Parameter Name	Description	Modbus Address	Par. Type
<b>FAN</b>	Indicate the state of the fan	13 bit12	Read Only

Option	Value
Off	0
On	1

Parameter Name	Description	Modbus Address	Par. Type
<b>Enable</b>	Indicate whether or not the power controller is enabled. The enable signal must be on for the unit to output power to the load	14 bit2	Read Only

Option	Value
Off	0
On	1

Parameter Name	Description	Modbus Address	Par. Type
<b>SP Source</b>	Indicate whether the power controller is local or remote set point mode	14 bit1	Read Only

Option	Description	Value
<b>Local / Comms</b>	Set Point via keypad or communication	2
<b>Remote</b>	Set Point via analog input	0

Parameter Name	Description	Range	Unit	Modbus Address	Par. Type
<b>Analog In1</b>	Indicates the percent of full scale measured by analog input 1	0 to 100.0	%	138	Read Only
<b>Analog In2</b>	Indicates the percent of full scale measured by analog input 2	0 to 100.0	%	137	Read Only
<b>SW Ver</b>	Indicates the software version number (x.xx.x)	0 to 65535		48	Read Only
<b>SW Rel</b>	Indicates the software release date year and week (yyww)	0 to 65535		49	Read Only
<b>Unit Type</b>	Indicates the type of power controller			36	Read Only

Option	Description	Value
<b>RC 1</b>	Single Phase	7
<b>RC 2</b>	Two Leg, three phase	8
<b>RC 3</b>	Three Leg, three phase	9
<b>RC 3P</b>	Three Leg, three phase with phase angle capability	9999

Parameter Name	Description	Range	Unit	Modbus Address	Par. Type
<b>Max Voltage</b>	Indicates the maximum voltage rating of the power controller	0 to 1023	V	41	Read Only
<b>Max Current</b>	Indicates the maximum current capacity of the power controller	0 to 9999	A	62	Read Only
<b>Aux Voltage</b>	Indicates the measured line voltage	0 to 1023	V	43	Read Only
<b>Serial No</b>	Indicates the serial number of the power controller	0 to 9999		149-150 151-152	Read Only
<b>SCR Temp</b>	Indicates whether the SCR is below or above the factory-set trip point			127	Read Only

Option	Description	Value
Disabled	No sensor present / temperature below limit	0
Over Temp	Over temperature	130

## 10

## Using the Configurator

Configurator software can be used like an alternative of the power controller's keypad and set the advanced features not available via the power controller's onboard user interface. Here we explain how to use it.

### 10.1 Typical Uses

The software may be used during commissioning to:

- set internal parameter do determine how the power controller operates and performs;
- save and restore a setup, copy or clone one power controller to another;
- on a day-to-day basis to monitor operation and power usage;
- to examine performance in more detail to determine if any corrective actions are needed.

### 10.2 Communicating with Power Controllers

When commissioning the power controller, may be useful to connect via the USB port, located below the control panel's display, a computer, so it's possible to configure and examine the settings of the controller. The controller's electronics is powered vis USB cable, so it's to possible inspect it before applying power.



**NOTE!** the power of the USB port is limited and not designed to power industrial cards, so it manages to feed only the essential parts of the electronics. For complete control, you need to power up the auxiliaries of the power controller.

### 10.3 Recipes

A recipe is a file that store the settings of power controller internal parameter.

Is used to save a power controller configuration or restore an existing configuration in a power controller.

#### 10.3.1 Upload a recipe

A recipe is created using upload function Configurator software and saving it as a file on the computer.

#### 10.3.2 Download a recipe

An existing recipe can be download to a power controller using download function in Configurator software

### 10.4 How To

Here the procedures for common tasks are described step-by-step.

#### 10.4.1 Install and communication with the power controller

**Procedure to install the Configurator:**

- 1) Locate the installer:
  - On [https://www.cdautomation.com/wp-content/uploads/ThyristorConfigurator\\_ver6.zip](https://www.cdautomation.com/wp-content/uploads/ThyristorConfigurator_ver6.zip) link is possible Download it
  - On the Controls Tools DVD ROM disk.
- 2) Double-click on the installer program to start installation.
- 3) Follow the on-screen instructions.

The screenshot shows the CD Automation website for the Thyristor Configurator software. The page features a navigation menu with options like HOME, SCR POWER CONTROLLER, APPLICATION, and SOFT STARTER. Below the menu, there's a breadcrumb trail: Home > Thyristor Power Controller > REVO C 3PH > Home > Controls Tools > Power Controller > Single Phase. The main content area includes a diagram of the REVO C 1 PH power controller with various input and output terminals labeled. To the right of the diagram, there's a text box that reads: "USB device on front unit for configuration: Standard easily and safely normally used to configure the REVO C. Eliminate the user having to work in a high voltage environment because the unit is powered through USB connections." Below this, there's a section titled "DOWNLOAD HERE THE FREE SOFTWARE TO CONFIGURE THE UNIT:" which provides instructions on how to use a USB cable to connect the unit to a computer. At the bottom, there's a download button for the software, labeled "Thyristor Configurator V5.6.4.3" with a file size of 23.5 MB and a date of 20 May 2010.

**Procedure to communicate with a power controller:**

1) **if used direct USB connection:**

- Connect the USB cable between the computer and the micro USB connector on the power controller's keypad
- if necessary, Wait for the USB driver to install.

2) **if used RS-485 connection** connect the power controller terminal to computer RS485 port. Usually the standard pc do not have a RS485 port so a USB-to-485 converter is required.

3) Launch the Configurator software and select

- **REVO C:** for single phase
- **REVO C 2PH:** for 2 phase power controller
- **REVO C 3PH:** for 3 phase power controller

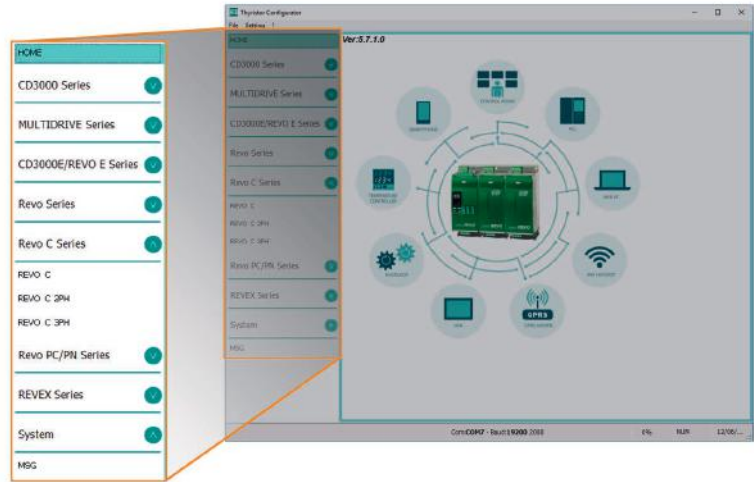

4) Choose **Serial Port** From the **Setting -> Serial Port** menu

5) In value **Port**, select the connected COM port to the power controller (see the note below)

6) To verify communications, click **Test**

7) Click **OK**



**NOTE!** to determine which port is connected to the power controller, you can:

- in the Windows" Device Manager under Ports (COM & LPT), looking for the COM port named "LPC USB VCOM Port (COMx)" where x is the port number
- On configurator software:
  - open the software without connect the unit and see the available com port on com port window setting,
  - close the com setting window,
  - connect the USB cable to the power controller (wait for the USB driver to install if necessary),
  - open the com setting window and see the added com number and select it.

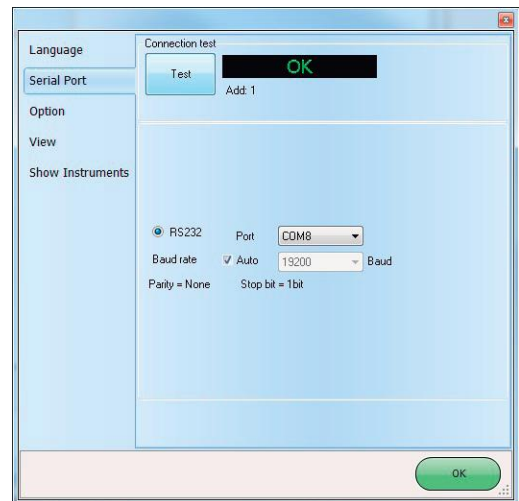

### 10.5 Using the Configurator

After software has been installed, communication has been set up and model type selected, it is possible to operate with the power controller.

#### 10.5.1 To view or save a power controller's settings using "Simple" view section:

- 1) Click **Simple**, if not already on the simple view
- 2) Click **Upload from unit**
- 3) Set the address, if necessary
- 4) Click **READ->**
- 5) Wait for the software to read the parameter settings
- 6) Click **OK**
- 7) If need save the settings in a recipe file:
  - Click **Save**
  - Name the recipe
  - Click **Save** button

**NOTE!** In the simple view the changes are not "live", so to take effect the changes in the simple section is necessary to download them with the download procedure.

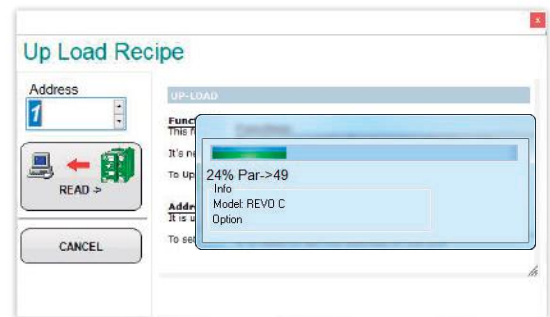
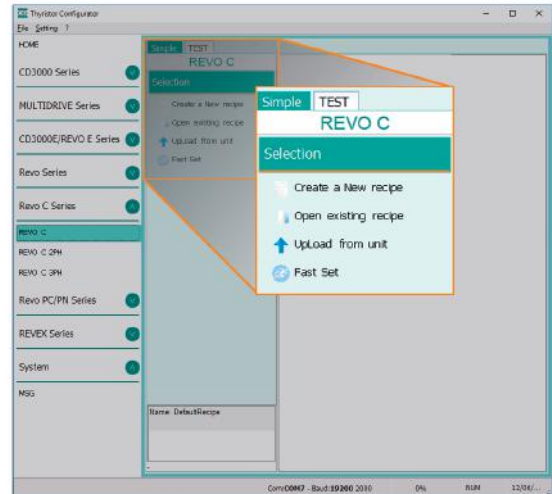

#### 10.5.2 To edit a setting in a recipe:

- 1) Click **Simple**, if not already on the simple view
- 2) Click **Open** existing recipe
- 3) Locate and select the recipe file and click **Open**
- 4) Click **OK**
- 5) Click the menu with the setting you want to change
  - **SETUP**
  - **ADVANCED SETUP**
  - **HARDWARE**
  - **COMMUNICATIONS**
- 6) Select the value you want to change
- 7) Edit the value with the increment and decrement buttons in the field or type the new value and press the Enter key
- 8) Repeat steps 5 to 7 for all the changes you want to make
- 9) To save the settings in a recipe file:
  - Click **Save**
  - Name the recipe
  - Click **Save** button

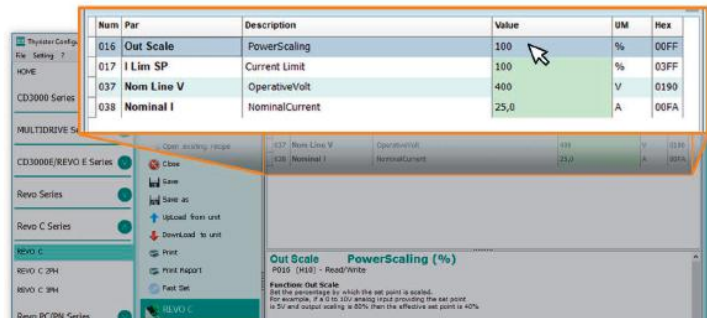



**10.5.3 To download a recipe file into a power controller:**

- 1) Click **Simple**, if not already on the Simple view
- 2) Click **Open** existing recipe
- 3) Locate and select the recipe file and click **Open**
- 4) Click **OK**
- 5) Click **Download to unit**
- 6) Set the address, if necessary
- 7) Click **SEND->**
- 8) Wait for the software to write the parameter settings
- 9) Click **OK**

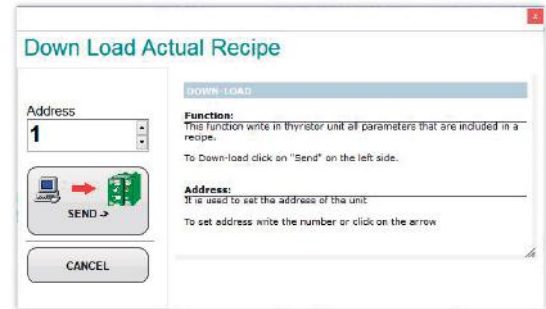

**10.5.4 To monitor a power controller with the Test view:**

- 1) Click **Test**, if not already on the test view
- 2) Click **Online**

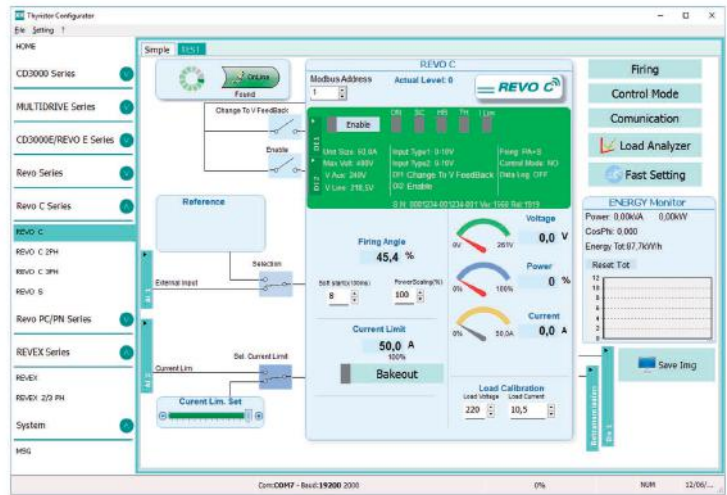

**10.5.5 To log in on the test view to change the digital input and analog input functions:**

- 1) Click the **Access Level** value (zero when logged out)
- 2) Type the password: **1111**
- 3) Click **OK**

**10.5.6 To log out the test view:**

- 1) Click the Access Level value
- 2) Click **Log out**
- 3) Click **OK**

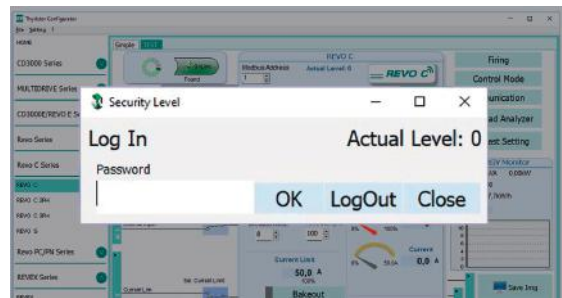

**10.5.7 To view data on the scope:**

- 1) Click **Test**, if not already on the test view
- 2) Click **Online**
- 3) Click **Load Analyzer**
- 4) For each of up to three channels (Ch 1 to Ch 3):
  - With **PV1** choose the value to monitor
  - Select **Show**
  - Click the color switch to change the color
  - Click the button to turn the channel on.



**10.5.8 To reset the power totals:**

- 1) Click **Test**, if not already on the test view
- 2) Click **Online**
- 3) Click **Reset Totals**
- 4) Click **Yes**

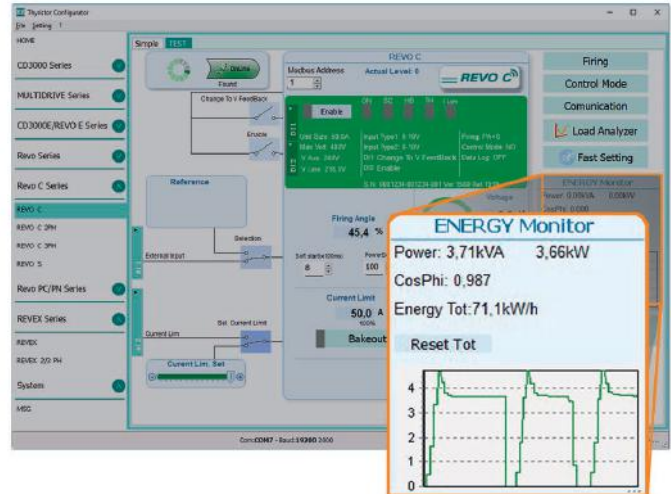

**10.5.9 Setting Up and Using Data Logging**

**To set up data logging:**

- 1) Click **Test**, if not already on the test view
- 2) Click **Online**
- 3) Click **Load Analyzer**
- 4) On the **Load Analyzer** view click **Data Log**
- 5) In the **Data Log** window ensure the slider is set to **Log Enabled**
- 6) Click **Set Time**
- 7) If necessary Set the date and time and close the date/time window
- 8) Set **Log Time** to the number of seconds between records
- 9) Click **Connect**
- 10) Click **Config**
- 11) Click **Load Configuration** to view the current list of logged parameters
  - 12) For up to ten parameters to log:
    - Click **+** to add a parameter to the list
    - In a row in the list either: Type a parameter's Modbus address in the **Par** field OR
    - Select the parameter from the drop down list in the **Name** field
  - 13) Click **Write Configuration** to send the parameter list to the controller
- 14) Click **Close**
- 15) Click **Disconnect**
- 16) Close the **Data Log** window

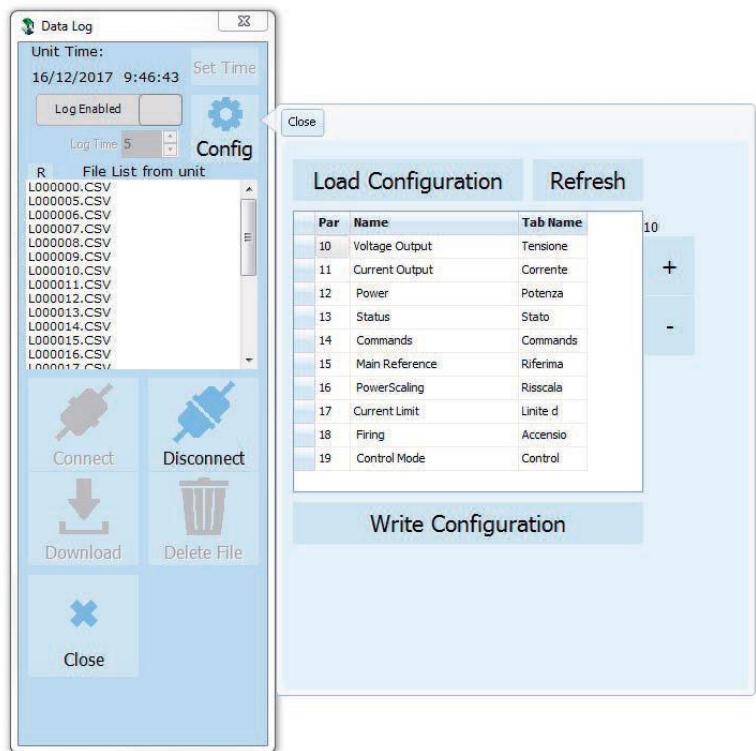



**10.5.10 To retrieve a data log file from the power controller:**

- 1) Click **Test**, if not already on the test view
- 2) Click **Online**
- 3) Click **Load Analyzer**
- 4) Click **Connect**
- 5) Select a file from the list
- 6) Click **Download**
- 7) Select a location and click **Save**
- 8) Wait for the file to download. This can take up to ten minutes for the largest file
- 9) To delete the log file from the controller memory, if desired, click **Delete File**
- 10) Click **Disconnect**
- 11) Close the **Data Log** window
- 12) Close the **Load Analyzer** window

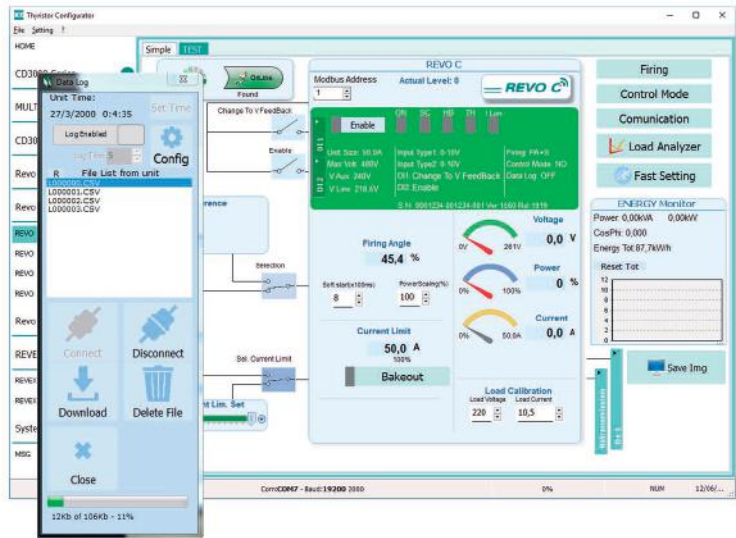

**10.6 Software General information**

Here it is described the Configurator Software and how use it.

**10.6.1 Program Window**

**Main Menu**

Access these menus.

**File menu**

**Exit:** close the program

**Setting menu**

**Language:** open language Settings dialog box

**Serial Port:** open Serial Port dialog box

**Option:** open General Option dialog box

**? (Help) menu**

**Message Log:** open a serial communication message view

**About:** displays the About dialog with the program name and version and contact information

**Instruments selector**

Select the right instrument to use:

**HOME:** the default view

**REVO-C:** open the Simple and Test views for a single-phase power controller

**REVO-C 3PH:** access the Simple and Test views for a three-phase power controller

**MSG:** opens a serial communication message view

**Status Bar**

Indicates information such as time and date, communications port and baud rate.



### 10.6.2 Simple Section

This section is used to create, save, upload and download recipes of parameters settings. Can be used also to see the settings in a controller.

Simple page is the default page when select the model using the Model Button, but If not selected is possible access it clicking the Simple tab below the main menu.

**NOTE!** This section is not "OnLine" so the parameter values are not updated continuously. They are read only when you upload them from the power controller.

To manage recipe click on:

- Create a New recipe:** create a recipe file with the standard default settings
- Open existing recipe:** open an existing recipe file
- Upload from unit:** create a new recipe with the value uploaded from a connected power controller
- Close:** close the current recipe
- Save:** save the recipe in a file
- Save as:** save a copy of the recipe in a file
- Download to unit:** send the current recipe parameters in the connected power controller
- Print:** print the recipe (see sample at right)
- Print report:** print the recipe (see sample at right)

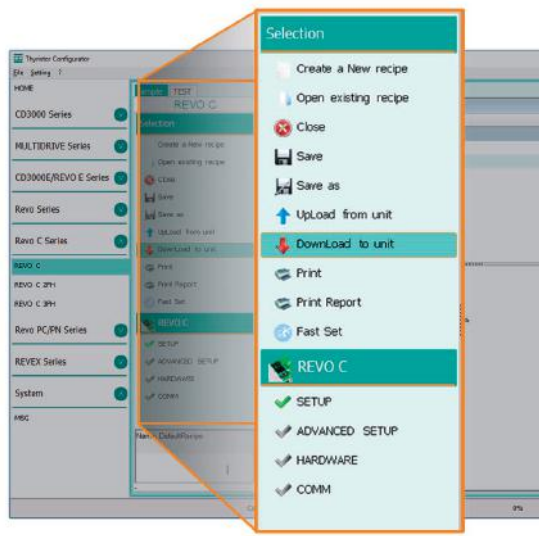

REVO C	Estados	16/11/2016 13:41:11
<b>SETUP</b>	On	VM
010	Out Scale	PowerScaling
011	I Lim SP	Current Limit
012	Nom Line V	OperativeVolt
013	Nominal I	NominalCurrent
014	...	...
015	...	...
016	...	...
017	...	...
018	...	...
019	...	...
020	...	...
021	...	...
022	...	...
023	...	...
024	...	...
025	...	...
026	...	...
027	...	...
028	...	...
029	...	...
030	...	...
031	...	...
032	...	...
033	...	...
034	...	...
035	...	...
036	...	...
037	...	...
038	...	...
039	...	...
040	...	...
041	...	...
042	...	...
043	...	...
044	...	...
045	...	...
046	...	...
047	...	...
048	...	...
049	...	...
050	...	...
051	...	...
052	...	...
053	...	...
054	...	...
055	...	...
056	...	...
057	...	...
058	...	...
059	...	...
060	...	...
061	...	...
062	...	...
063	...	...
064	...	...
065	...	...
066	...	...
067	...	...
068	...	...
069	...	...
070	...	...
071	...	...
072	...	...
073	...	...
074	...	...
075	...	...
076	...	...
077	...	...
078	...	...
079	...	...
080	...	...
081	...	...
082	...	...
083	...	...
084	...	...
085	...	...
086	...	...
087	...	...
088	...	...
089	...	...
090	...	...
091	...	...
092	...	...
093	...	...
094	...	...
095	...	...
096	...	...
097	...	...
098	...	...
099	...	...
100	...	...

To edit the actual recipe values click a parameter menu name:

- SETUP**
- ADVANCED SETUP**
- HARDWARE**
- COMMUNICATIONS**

and after click on the value and modify it.

**NOTE!** Changes to the values here affect the open recipe only. To apply these changes to the power controller settings, download them to the power controller using the Download to unit option.

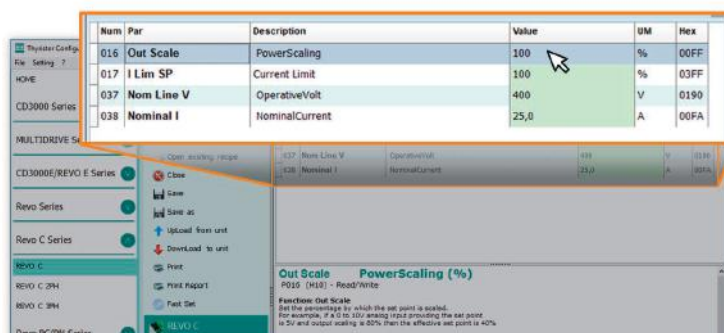

### 10.6.3 Test Section

This section is used to monitor and adjust the operation of the power controller in real time using RS485 or USB communication port.

After select the model, is possible access to this section clicking the "TEST" tab below the main menu.

#### Operating on TEST Section:

**Online** button: is the button to start or stop communication updates with the power controller

After communication start a green communication status indicator sweeps clockwise when the software is communicating right with a power controller, is the connection link is broken the color will become red

**Address:** value used to set the power controller address

**Access Level:** click the value to log in or out. Default Password address is "1111".

#### To configure and monitor the digital inputs:

##### Digital input states and functions:

show whether each input detects an open or closed circuit and the function the input performs.

##### Digital Input States and Function Selectors:

set the function for each digital input. Click DI1 or DI2 to expand the options.

##### Status and Setup Indicators:

**Digital input status:** light on when the input is a closed circuit

**Enable indicator:** light on when the power controller is enabled

**Enable/Disable button:** click on to enable the power controller if a digital input is not configured for this function

**ON indicator:** light on when there is demand for the output to be on

**SC indicator:** light on when there is a shorted SCR alarm active

**HB indicator:** light on when there is a heater break alarm active

**TH indicator:** light on when the heat sink over temperature alarm is active

**I Lim indicator:** light on when the load current exceeds the current limit setting

**Unit Size:** Indicate the maximum rated current of the power controller

**Max Volt:** indicate the maximum rated voltage for the power controller

**V Aux:** indicate the voltage the auxiliary input is set to use for powering the electronics

**Input Type1:** indicate the signal analog input 1's type

**Input Type2:** indicate the signal analog input 2's type

**DI1:** indicate digital input 1's function

**DI2:** indicate digital input 2's function

**Firing:** indicate the firing type the power controller is set to use

**Feedback:** indicate the feedback type the power controller is set to use

**Data Log:** indicate the Data Log status.

**Fuse indicator:** light on when if a fuse is burned

**Fan indicator:** light on if the fans are not working properly

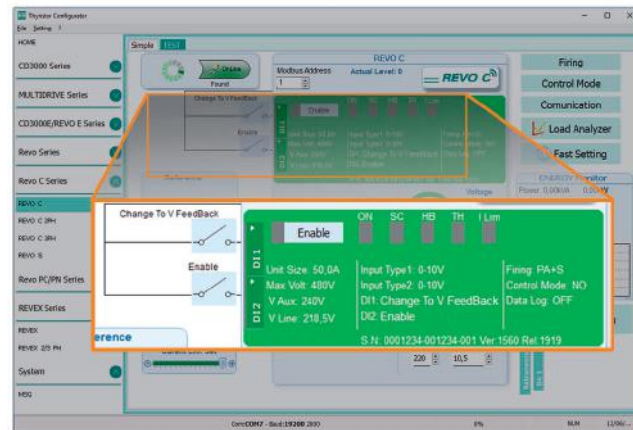
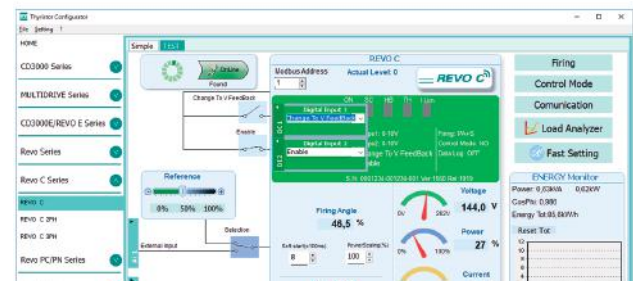
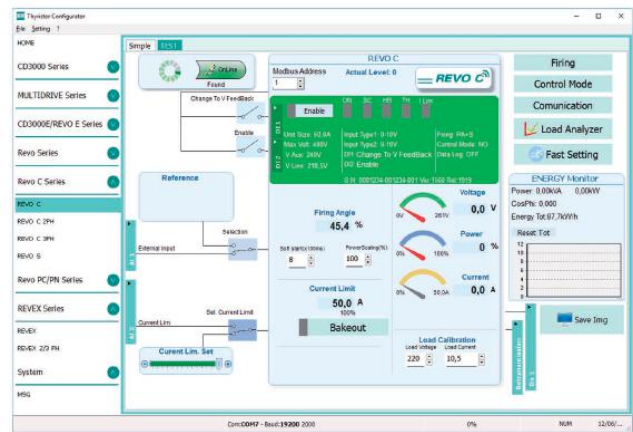

**Buttons setup options:**

- Firing:** view and set the firing type and the associated parameters
- Feedback:** view and set feedback type
- Communication:** view and set communication options for ports, protocols and fieldbus

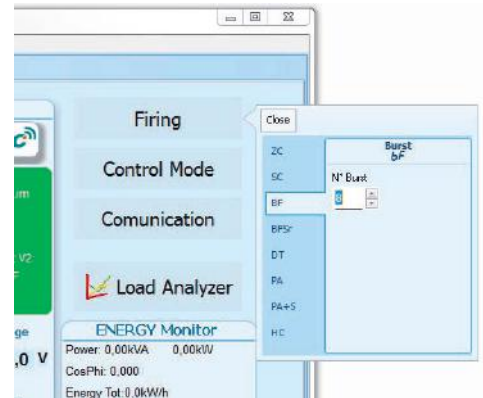

**Configure and monitor the analog inputs:**

- Analog Input 1:** click Ai 1 to view the signal type
- Input Local/Remote selection button:** click to toggle between using the signal received at analog input 1 (remote) or the slider (local) to set the set point.
- Reference:** drag the slider, click the increment (+) or decrement (-) buttons or click one of the three percentages (0%, 50% or 100%) to set the set point when the set point source is set to local.
- Analog Input 2:** click Ai 2 to view the signal type and function

**To configure and monitor the power controller:**

- Power Request:** show the set point signal from analog input 1. The value is a percent of full scale or can be set with the reference slider
- Soft Start Time:** show the time over which set point changes are ramped
- Output Scaling:** show the scaling applied to the set point signal before it is used by the control loop
- Voltage indicator:** show RMS load voltage
- Power indicator:** show RMS load power
- Current indicator:** show the RMS load current
- Current Limit Set:** indicates the current limit set point
- Bakeout button:** click to view and set the heater bakeout feature options
- Load Calibration:** set and view the nominal line voltage and nominal load current settings for the application.

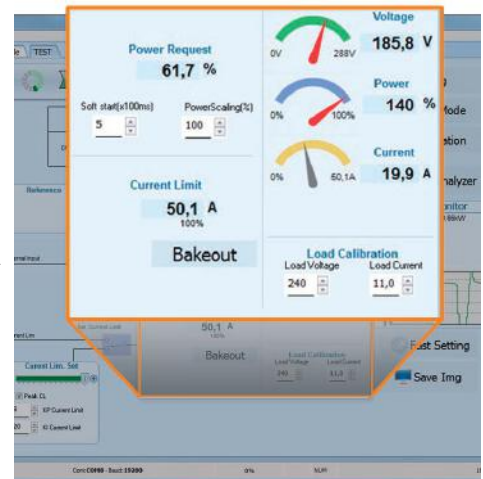

**NOTE!** The Load Calibration settings, Load Voltage and Load Current define 100% power for the load.

- Energy Monitor:** indicates power, power factor and energy usage over time which may be reset with the **Reset Tot** button.
- Data Log:** If present is used to configure the data logging feature data logs.
- Save Image:** click to save a JPEG file with an image of the test Page.

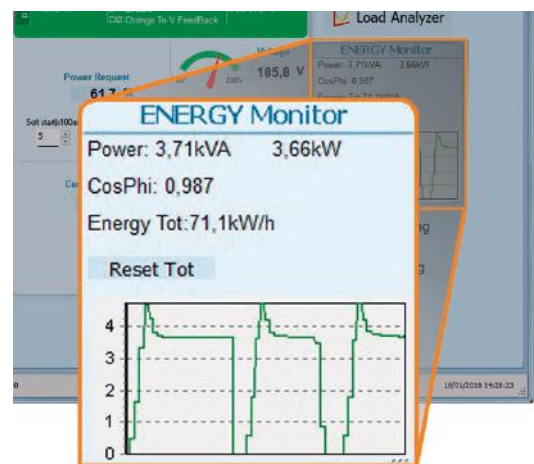



### 10.6.4. Load Analyzer

Load Analyzer is used for monitoring values graphically represent

Click on **Load Analyzer** button on the test page will open Load Analyzer window.

Is possible see 3 channels (Ch 1, Ch 2 and Ch 3). For each channel configure a pen on the graph:

**On/Off button:** click to start trending data reading

**PV:** choose the parameter to trend

**Show:** set this option to display or hide the trend

**Show Mark:** set this option to display data markers along the trend in the graph area

**Live!:** click to view the current waveform on the graph.

**Data Log:** click to open the Data Log window.

The **Historical** options to control the movement of the chart:

**Scroll left-click:** move the chart left to view more recent data

**Stop/Play-click:** toggle the live view or Hystorical view of graphic signal

**Scroll right-click:** move the chart right to view older data

The **Actions** to:

**Clear:** to clear the data from the graph

**Save:** to save a JPEG image of the **Load Analyzer** window with the current trends

**Export:** to open a window that includes the trend graph and table with the currently displayed data that can be saved as a JPEG or exported to a CSV file.

Use the **X – Scale** settings to adjust the horizontal (time) axis:

**Min:** set the minutes of data displayed

**Sec:** set the seconds of data displayed

**Filter:** set this option to filter the data

Use the **Y – Scale** settings to adjust the vertical (percent of full scale) axis

**Max:** set the maximum value for the vertical axis

**Reset:** click to reset the vertical axis scaling



**NOTE!** Use the increment (up arrow) and decrement (down arrow) buttons to adjust the x and y scales. Numeric entry does not allow the full range of values to be set.



### 10.6.5 Data Log Window

In the power controller the data log window is used to manage files and set up logging parameter like log interval time and date/time in rtc

- Log Enabled/Log Disabled slider:** Enable and disable data logging function.
- Log Time:** the time between data log records in seconds
- Config:** opens the data log configuration window to customize the variable to log
- File List:** lists the data log files available in the power controller
- Connect:** the power controller enter in log mode and permit the file manage
- Disconnect:** the power controller close the log mode
- Download:** download the selected file from the power controller to the computer
- Delete File:** erases the selected file from the power controller
- Close:** closes the Data Log window and close the log mode on power controller.

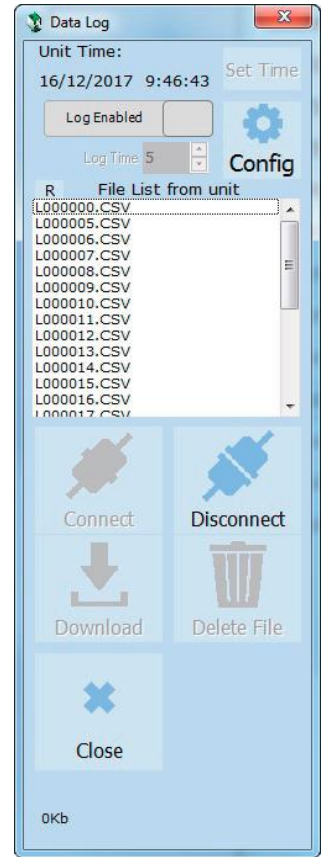

### 10.6.6 Data Log Configuration window

Data log configuration window is used to view and set the parameter log table.

- Close:** closes the window
- Load Configuration:** refresh and displays the list of parameters being logged

#### Logged parameters list-the parameters configuration table

**Par:** view or enter the Modbus address of the parameter to log

**i NOTE:** is possible to set all parameter number describe in the Modbus communication manual

**Name:** view or choose by name of common parameter to log

**Tab Name:** indicates the name of the logged parameter as displayed in the log file

- + button:** adds a row to the list
- button:** removes the last row from the list

**Write Configuration:** sends the list of parameters to be logged to the controller

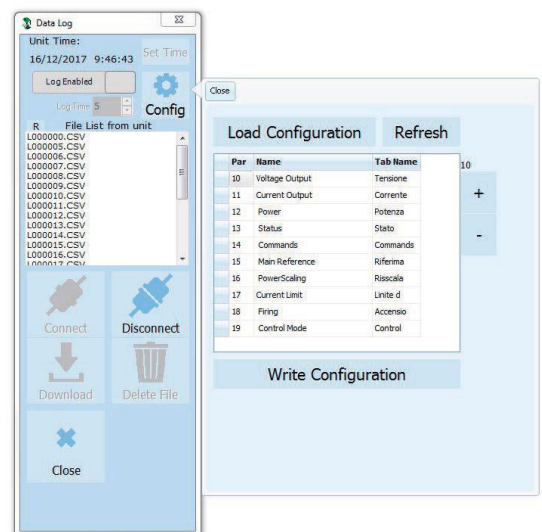

### 10.6.7 MSG view

Message view display the communication activity between the computer and the power controller.

#### PORT

**COM:** use this view to see when the COM port is accessed and its settings

**MODBUS:** Modbus communication protocol area

**READ Area:** use this view to see parameters being polled

**READ Area -> En Log:** enable a short read communication log activity

**READ Area -> En Detail:** if En Log enabled enable a detailed read communication log activity

**READ Area -> Only Error:** if En Log enabled enable a read communication log activity only if in error

**WRITE Area:** use this view to see what parameters and the value are send power control

**READ Area -> En Log:** enable a write communication log activity

**Log Msg:** use this view to see the "Data Log" protocol detail when Data Log windows is active

**Status:** view the status and settings of the COM port

#### SYSTEM

**Memory:** view the memory usage of the Configurator program on the computer

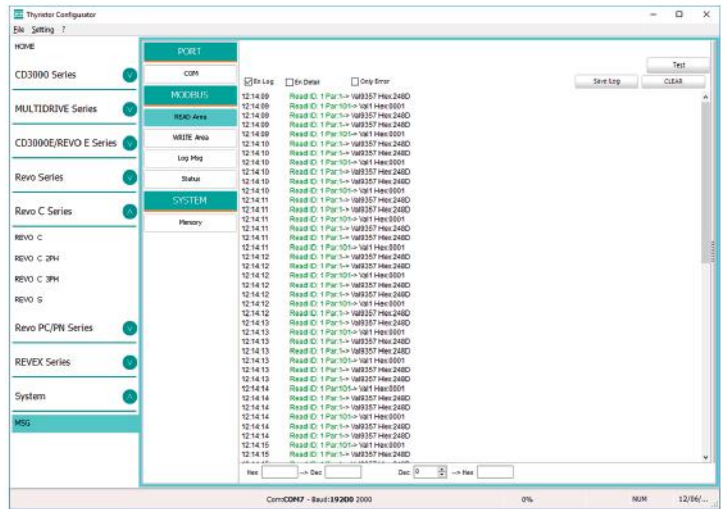

### 10.6.8 Settings window

Use this window to choose user-settable options for the Configurator software.

#### Language:

**Available Languages:** choose the language used in the program



**NOTE!** to be active the language change, need close and open again the configuration software

**Serial Port:** Set the serial port parameter

**Test:** click to test for communication with a power controller via the selected port

**Port:** select the computer's COM port to use to communicate with power controllers

**Baud rate:** select Auto to allow the Configurator to set the baud rate for the COM port or deselect the option to set the baud rate yourself

**Options:** Set the configurator options

**List Options:** set whether or not parameter values are displayed in hexadecimal in simple view recipes

**Directory:** set the directories in which recipes and images are saved

**Disable Check Type:** set to allow communication with power controllers that are not precise matches for the supported types. Used only for special version. Note that set is not memorized after software shutdown

#### View:

**Hide Tool Bar:** future use

**Hide Status Bar:** select to hide the status bar that appears at the bottom of the program window

**Show Instruments:** Hide or show the available instrument in the left side of main windows

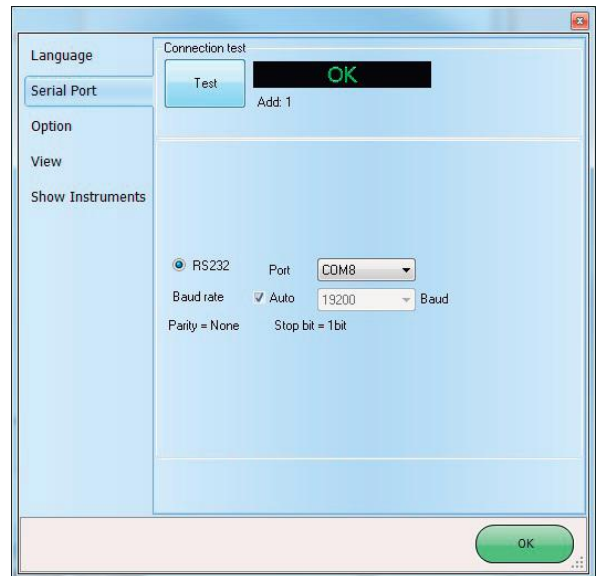

## 11

## Configurable inputs and Outputs

The REVO C power controller features two digital inputs, up to two analog inputs and a relay output. Some models also include an analog output for retransmitting a measured value to other automation equipment. This section describes the various functions of these inputs and outputs and how they interact with other features of the power controller.

### 11.1 Digital Inputs

The REVO C power controller has two optically-isolated, digital inputs that can be connected to control panel switches or other automation equipment such as a temperature controller or programmable logic controller. Using Digital In 1 Function and Digital In 2 Function on the hardware menu each digital input can be configured to perform one of the following:

- **Enable:** the power output is off unless this signal is on. If both digital inputs are set to this option, the state of digital input 2 takes precedence (DI2 Default Configuration).
- **Voltage Feedback:** this signal overrides the feedback setting. When this signal is on, the control loop uses voltage feedback. When the signal is off, the loop reverts to the feedback parameter setting (DI1 default Configuration).
- **Local / Remote:** this signal selects how the set point is set. When this signal is on, the control loop's set point is set using the keypad or through communications. When this signal is off, the set point is set by the an analog input. When a digital input is set to this function, the Local/Remote (L/R) button on the front panel cannot be used to choose the source of the set point.
- **Phase Angle:** this signal overrides the Firing setting. When this signal is on, the power controller uses phase-angle firing. When the signal is off, the controller uses the method set with the firing parameter on the advanced setup menu.
- **SP Analog In 1 / 2:** this signal chooses which of the two analog inputs is used as the source of the set point when the remote set point is in effect. When this signal is off, analog input 1 is the source of the remote set point. When the signal is on, analog input 2 is the source of the remote set point.
- **Logging:** this signal turns data logging on or off. When the signal is on, data is logged. When the signal is off, data is not logged. When this signal is on, it supersedes the setting of the Logging parameter on the advanced setup menu.
- **Heater Bakeout:** this signal turns the heater bakeout feature on or off. When the signal is on, the heater bakeout feature is enabled. When the signal is off, the heater bakeout feature is disabled. When this signal is on, it supersedes the setting of the Heater Bakeout parameter on the advanced setup menu.
- **Fast Enable (SSR Input):** configuration used for SSR input (see figure in paragraph 8.7.1). This input configuration allows controlling the unit with a logic signal (ON / OFF) with voltage  $4 \pm 30\text{Vdc}$   $5\text{mA Max}$  (ON  $\geq 4\text{Vdc}$  OFF  $< 1\text{Vdc}$ ) -  $3\text{HZ Max}$  on time min. 100 ms. When the Fast Enable input is enabled, Phase Angle firing is automatically selected.
- **Alarm Reset:** reset the Alarm relay Output if an alarm/s triggered. When this function is selected, and the digital input is on, the HB alarm resets. If the Digital Input is off and the problem persist, the alarm is reactivated.

To configure how the power controller uses these signals, see "Digital In 1 Function" and "Digital In 2 Function" on Paragraph **9.4.4 Hardware menu**.

### 11.2 Analog Input 1: Set Point

To control the power to the load with a device such as a temperature controller, connect the control signal to analog input 1.

This input accepts current, voltage and potentiometer signals. The signal is interpreted as set point by comparing the measured value to the input's full scale. For example, the set point is 50% when the analog input detects 5V and the input is configured to receive 0 to 10Vdc.

Configure the power controller to recognize the signal with the hardware menu; see "Analog In 1" on Paragraph **9.4.4 Hardware menu**. For instructions for wiring see paragraph 8.7 Schematic.



### 11.3 Analog Input 2: Set Point, Feedback or Current Limit Set Point

What this input does is user-configurable. Connect an analog signal that indicates:

- An alternate set point signal
- Measured power, voltage or current from an external device used as feedback
- Maximum current to the load (current limit).

This input accepts current, voltage and potentiometer signals. The signal is interpreted by comparing its measured value to the input's full scale. For example, the signal is 50% when the analog input detects 12mADC and the input is configured to receive 4 to 20mADC.

Configure the power controller to recognize the signal and how the power controller uses it on the hardware menu; see "Analog In 2" on Paragraph **9.4.4 Hardware menu**. For instructions for wiring see paragraph 8.7 Schematic.

### 11.4 Alarms and Alarm Relay Output

When an alarm occurs and while the condition persists, the alarm relay is de-energized. The alarm relay is energized when power is supplied to the controller's electronics via the auxiliary power input and there are no alarms.

Choose which conditions determine the alarm relay output with the Alarm Function setting on Paragraph **9.4.4 Hardware menu**.

#### Alarm Function Options

	Alarm Output Energizes for...				
	Heater Break	Shorted SCR	Current Limit	Communication Watchdog Error	Heat Sink Over Temperature
None					X
Heater Break (HB)	X				X
SCR Short (SC)		X			X
I Limit (IL)			X		
HB / SC	X	X			X
HB / IL	X		X		
SC / IL		X	X		
HB / SC / IL	X	X	X		
Watchdog (WD)				X	X
WD / HB	X			X	X
WD / SC		X		X	X
WD / SC / HB	X	X		X	X
WD / IL			X		
WD / IL / HB	X		X	X	X
WD / IL or SC		X	X		
WD / IL or SC / HB	X	X	X	X	X



**NOTE!** The alarm relay output indicates an alarm whenever the temperature of the heat sink is too high even when Alarm Function on the hardware menu is set to None.



**NOTE!** The power controller monitors for heater break or short circuit conditions only when included in the option selected for Alarm Function.

# 12 Alarm description

## 12.1 Heater Break Alarm

This option allows you to diagnose any load breakage. The diagnostics is based on the comparison of the value of the nominal resistance of the load with respect to the resistance measured in real time. The nominal resistance is calculated using the **Operative Load Voltage (Nom Line V)** and **Nominal Current of the Load (Nominal I)** parameters.

### Nominal Resistance $R = \text{Nom Line V} / \text{Nominal I}$

The alarm threshold value is the value of the nominal resistance increased by the percentage defined by the HB Sense parameter

Example:

Resistance 2200W @ 220V

power/voltage= A -->  $2200/220 = 10A$

- nominal V: 220 V

- nominal I: 10A

- Nominal resistance - R = 22 Ohm

HB sense parameter = 20% --> threshold value =  $22 + (22 \times 20 / 100) = 22 + 4,4 \text{ Ohm} = 26,4 \text{ Ohm}$

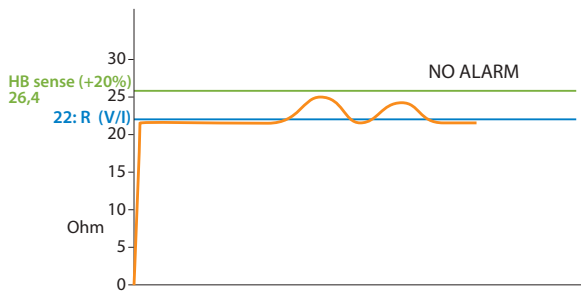

The alarm activates when the detected Runtime resistance exceeds the value of 26.4 Ohm.

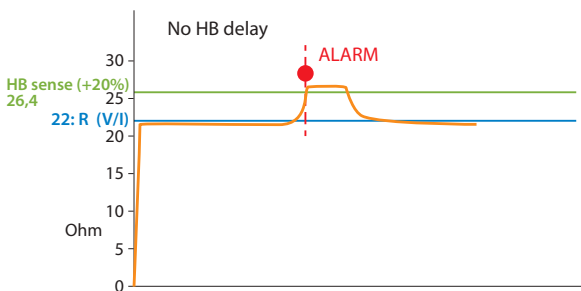

Using the HB Delay parameter, the alarm intervention can be delayed.

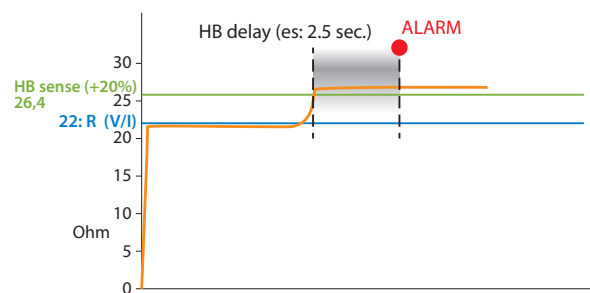
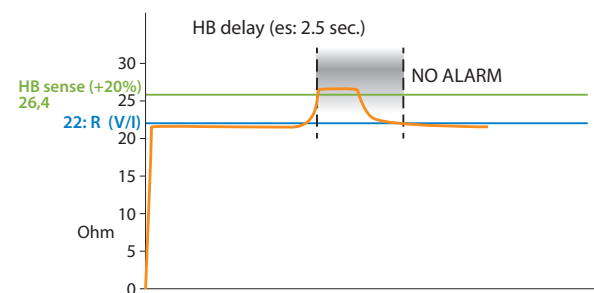

Sensitivity (HB sense) and delay (HB delay) can be varied according to the exercise (see parameters on pages 40-41).

### 12.2. AUX High

This alarm is displayed when the auxiliary supply voltage exceeds the established ranges. If the alarm situation persists for more than 5 seconds, the unit will go into protection.

### 12.3 AUX Low

This alarm is displayed when the auxiliary supply voltage is lower than the established ranges. This alarm condition could lead to incorrect unit operation.

### 12.4 ComError

If the communication watchdog function is enabled (watchdog ON) this alarm is activated when there is no data passage within the time established by the "WD reset" parameter.

### 12.5 AUX Line Loss

This alarm is activated when there is no auxiliary voltage.

### 12.6 I Limit

This alarm is activated when the operating current exceeds the current limit value set in the I Limit SP parameter.

### 12.7 SD Error

When the Logging option is present, this alarm is activated when a writing error is found in the SD memory.

### 12.8 SHRT

This alarm is activated if the unit detects a short circuit in one of the power devices. This alarm could also activate when the current measured by the unit is greater than 80% of the value set in Nominal I.

### 12.9 SCR Temp

This alarm is activated when the heat sink temperature exceeds the set threshold value (80°C).

### 12.10 Line Loss

This alarm is activated when L1 and L2 are not detected.

### 12.11 Phase Loss

This alarm is activated when L1 or L2 or L3 are not detected.

## 13

**“Enable” Function in static Unit**

The “Enable” function can work in several ways

- from Digital input
- from Serial Port
- from Digital Input + Serial Port
- from FieldBus
- from Digital Input + FieldBus

To simplify in the various diagrams, the “enable” command from serial port will be represented by a “Software contact” abbreviated as  $Sw_S$ , and the command from digital input is abbreviated as  $Sw_H$ .

**13.1 Using Digital Input only**

By setting the Digital Input as “Enable” it is possible to control the enable from Digital Input.

By closing the digital input via  $Sw_H$  contact, the unit will be enabled and by opening the digital input the unit will be disabled.

The status can be read on bit 2 of parameter 14 on the serial port.

If bit 2 = 1: Enabled

If bit 2 = 0: Disabled

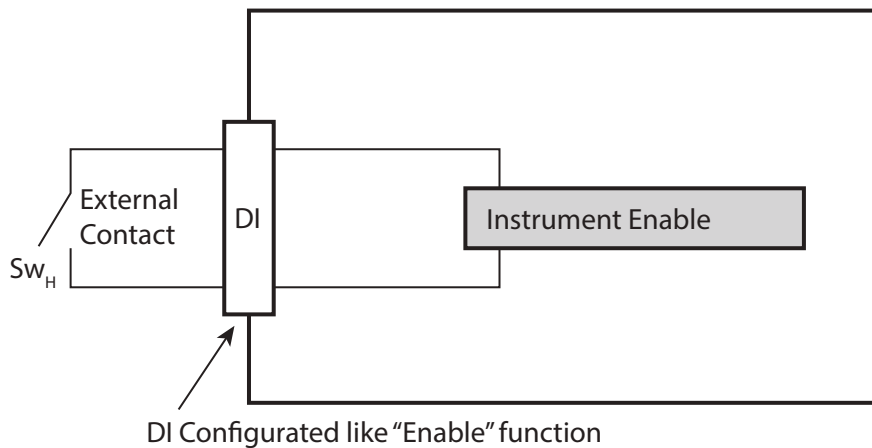

$Sw_H$  = Switch hardware

### 13.2 Using Serial Port RS485 only

The static unit has an RS485 Modbus RTU serial port always present. By setting the Digital Input as "Not Used" or different from "Enable" it is possible to control the enable from serial port with bit 2 of parameter 14  
 If bit 2 = 1: Enabled  
 If bit 2 = 0: Disabled

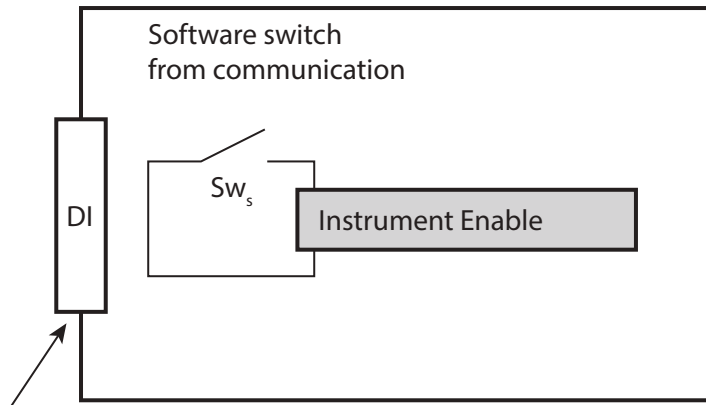

DI Function Configured like "Not Used" or different from "Enable"

Sw<sub>s</sub> = Switch software

### 13.3 Using Digital Input + Serial Port RS485

The static unit has the serial port as standard RS485 Modbus RTU always present. The external contact Sw<sub>H</sub> and the internal software contact Sw<sub>s</sub> are connected in series, therefore if you want to enable the static unit, both contacts must be enabled. Each variation of the Sw<sub>H</sub> contact connected on the digital Input (DI) is shown on the internal Sw<sub>s</sub> contact, allowing correct operation. Using the serial port it is possible to change the status of the Sw<sub>s</sub> contact with bit 2 of parameter 14, bearing in mind that it will be overwritten when the digital input is subsequently changed. This configuration is useful for having an external contact for a safety or emergency alternative to the serial command.

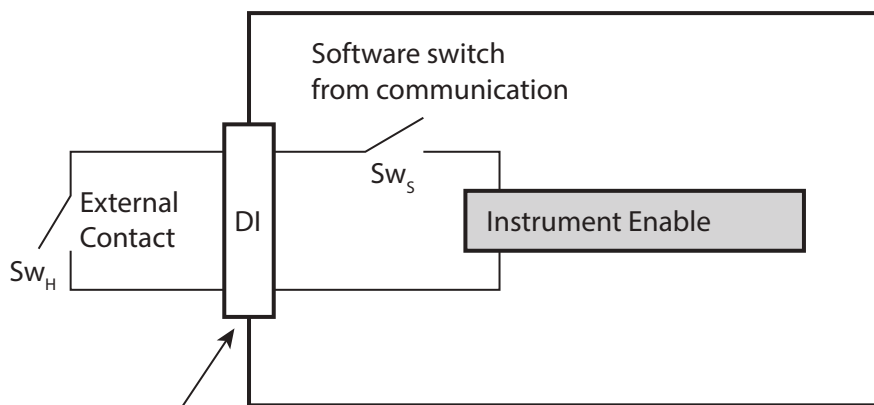

DI Configured like "Enable" function

Sw<sub>H</sub> = Switch hardware

Sw<sub>s</sub> = Switch software

### 13.4 Using FieldBus only

The static unit as an option can be ordered with a FieldBus (Ex: profinet).

This option continuously writes the values on the unit keeping them up to date.

Using the field bus it is possible to change the status of the  $Sw_s$  contact with bit 2 of the "Command table" (See the communication manual of the respective FieldBus).

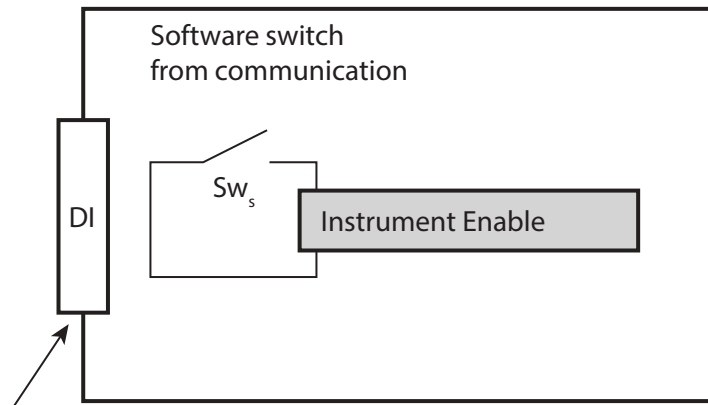

DI Function Configured like "Not Used" or different from "Enable"

$Sw_s$  = Switch software

**NOTE:**

The parameters written are:

- command table
- reference
- rescaling

if the FieldBus is active but disconnected these values will be forced to 0.

### 13.5 Using Digital Input + FieldBus

The static unit as an option can be ordered with a FieldBus (Ex: profinet).

This option continuously writes the values on the unit keeping them up to date.

The external contact  $Sw_H$  and the internal software contact  $Sw_S$  are connected in series, therefore if you want to enable the static unit, both contacts must be enabled.

Using the FieldBus it is possible to change the status of the  $Sw_S$  contact with bit 2 of the "Command table" (See the communication manual of the respective FieldBus), bearing in mind that the  $Sw_H$  contact must also be closed to enable it.

This configuration is useful for having an external contact for a safety or emergency alternative to the FieldBus.

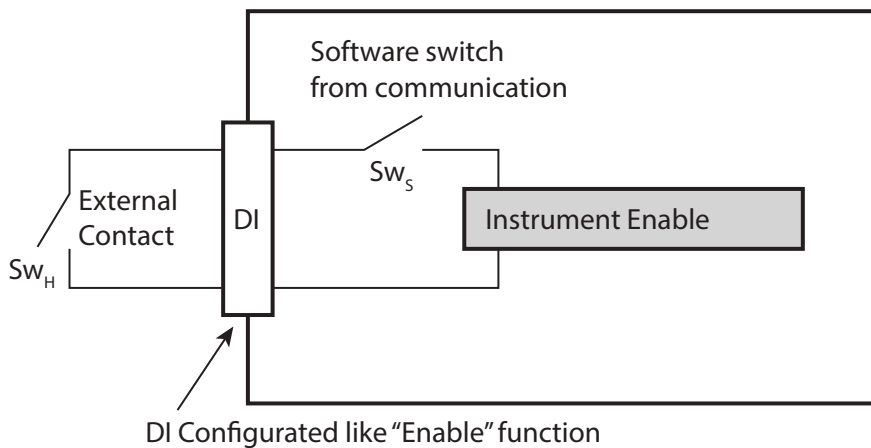

$Sw_H$  = Switch hardware

$Sw_S$  = Switch software

**NOTE:**

The parameters written are:

- command table
- reference
- rescaling

if the FieldBus is active but disconnected these values will be forced to 0.

# 14 Firing type

Choose a correct firing type allows to optimize the thyristor unit for the installed load. The firing type has already configured in line with customer requirements that are defined in the Order Code. The Order Code is written on the identification label. However, if you wish to change the firing type you can use the software configurator or the Control Panel.



**Caution:** this procedure must be performed only by qualified persons.

## 14.1 Zero Crossing

ZC firing mode is used with Logic Output from temperature controllers and the Thyristor operates like a contactor. The Cycle time is performed by temperature controller. ZC minimizes interferences because the Thyristor unit switches ON-OFF at zero voltage.

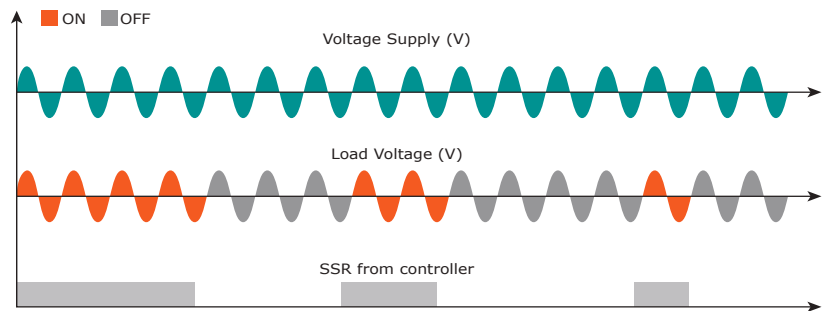

## 14.2 Single Cycle

Single Cycle it's the faster zero crossing switching method in relationship of the power demand from a temperature regulator or from an external signal. With input signal at 25% the output is one cycle ON and three cycles OFF. With input signal at 50% the output is one cycle ON and one cycle OFF. With input signal at 75% the output is three cycles ON and one cycle OFF. With input signal at 76% the output is the same of 75% but for each ON cycle the microprocessor divides 76/75, and when the sum of rests is one, the unit does one more cycle ON. For this firing is necessary to have analog input. The Single Cycle is used to control the loads with low inertia or for infrared lamps to short wave.

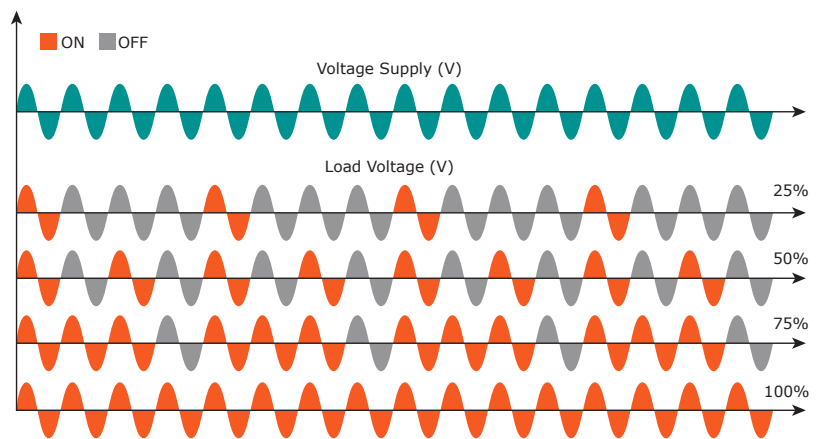

## 14.3 Burst Firing

The Burst Firing is similar to the Single Cycle, but consecutive cycles ON are selectable between 1 and 255, with input signal equal at 50%. When is specified 1 the firing type is Single Cycle. Burst Firing is a method zero crossing that it reduces the electromagnetic interferences because the thyristor switches at zero voltage crossing. The example show the Burst Firing with Burst cycles=4.

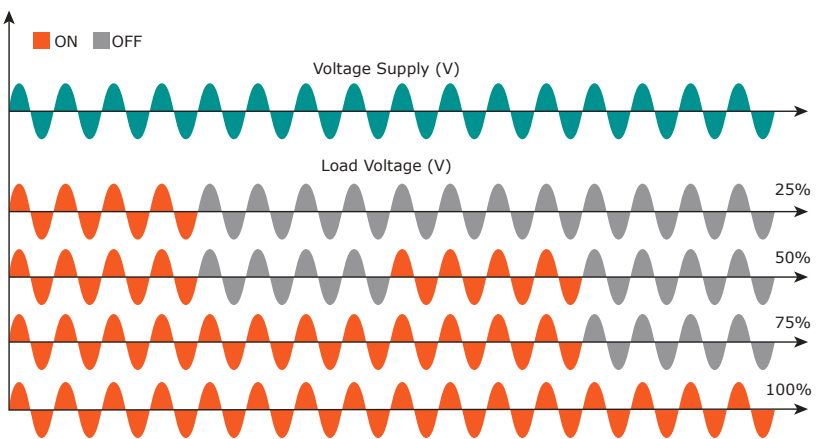



### 14.4 Soft Start with Burst Firing

This is an additional function to the Burst Firing. The unit start in phase angle mode with a ramp starting from zero up to the full tension in the cycles number set in the parameter. When the ramp is over, the thyristor unit will stay in conduction at full voltage up to the end of cycles of burst. The S+BF firing is used to control small inductive loads to avoid inrush surge current and to reduce the electromagnetic interferences. The example show the firing with Burst cycles =4 and start ramp half cycles=3.

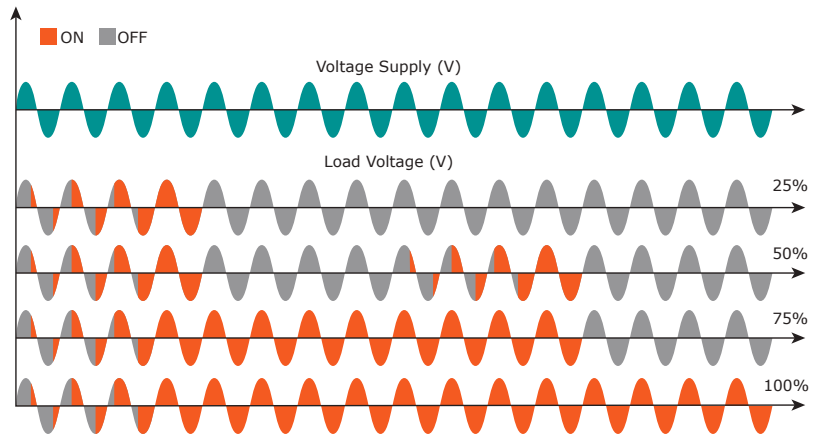

### 14.5 Phase Angle

The Phase Angle firing allow the control of the power on the load, for this firing the thyristor can be in conduction only for a part of the voltage cycle.

This part of the voltage cycle is adjustable in function of the input signal from 0 at 100%.

The PA firing is normally used for control the inductive loads, and is also possible control a primary of transformer coupled with the cold resistances like: Superkanthal, Molybdenum, Platinum, Tungsten or Quartz Lamp. The only disadvantage with phase angle is the possible generation of interferences that however can be reduced with oportune filters.

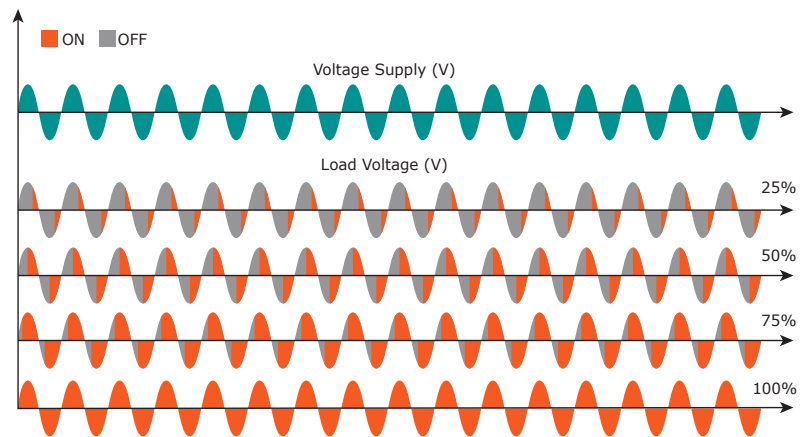

### 14.6 Soft Start with Phase Angle

This is an additional function to the Phase Angle. The firing angle of the thyristor increase or decrease up to the final setpoint value.

The Soft start ramp is an important feature to reduce the inrush current with transformers during the cycle of magnetization or with cold resistance that are near to the short circuit when they are supplied.

Setpoint Ramp Up / Setpoint Ramp Down.

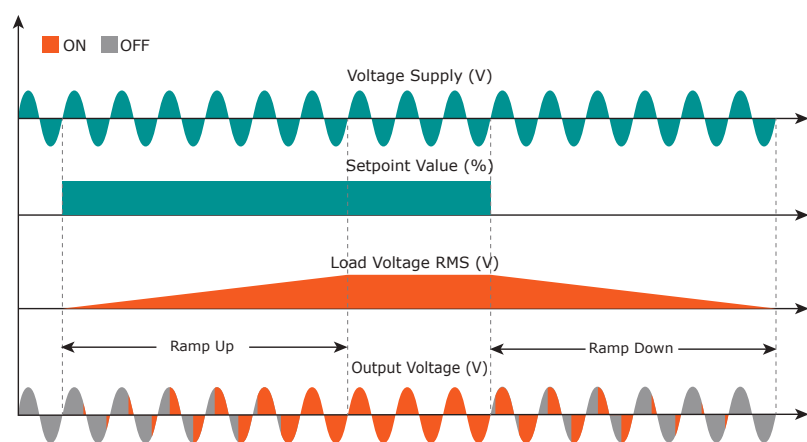

### 14.7 Delay Triggering with Burst Firing

The Delay Triggering firing is used to control a primary of transformer coupled with the normal resistances on the secondary (N.B. don't connect cold resistances on the secondary like: Superkanthal, Molybdenum, Platinum, Tungsten, Quartz Lamp).

For an inductive load (ex transformer), switching the thyristors at zero crossing can generate transient over currents that can blow the fuses, to avoid this problem you must use the Delay Triggering. This firing delay the first half cycle of Burst for an angle from 0 to 100° relative to the zero.

For understand the Delay Triggering firing, we have represented the waves generate by vectors that rotates in counterclockwise:

Without Delay Triggering

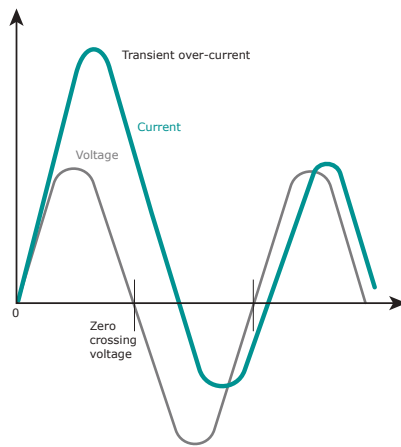

With Delay Triggering

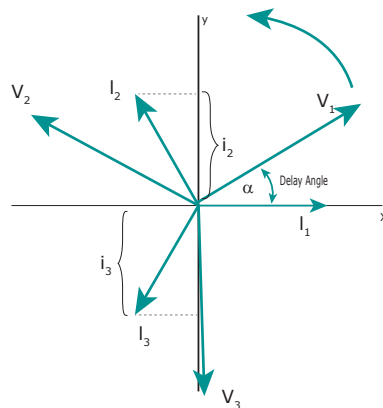
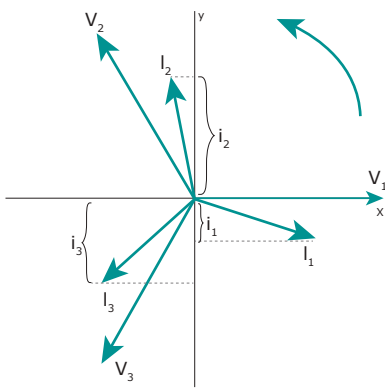
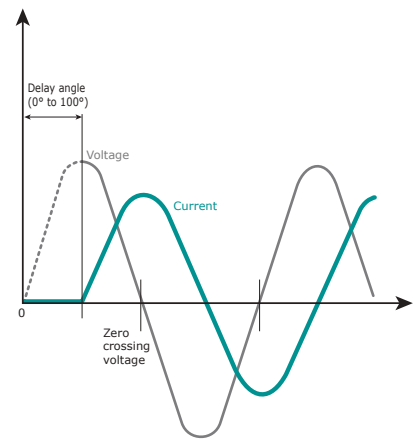

Without delay at zero crossing when  $V_1$  is to zero (projected on the X axis) the unit switch On.

In this case the instantaneous value of the currents are  $i_1, i_2$  and  $i_3$  and this condition, for the curve of magnetization, could generate transient over currents that can blow the fuses.

With Delay Triggering the firing of the thyristor are triggered with a delay until the instantaneous value of the current  $i_1=0, i_2$  positive and  $i_3$  negative like represented.

In this case the risk of transient

over currents is reduced and the fuses don't blow.

The angle alpha is the delay to have  $i_1=0$  and this angle depends on the power factor.

The delay angle suggest for most applications is 80°

## 15

## Current Limit

The Current Limit is available on REVO CL with Phase Angle firing mode only. It control the firing angle of the thyristor to maintain the three RMS current under the set value. When the current exceeds this value, the voltage is decreased up to reach the current limit set.

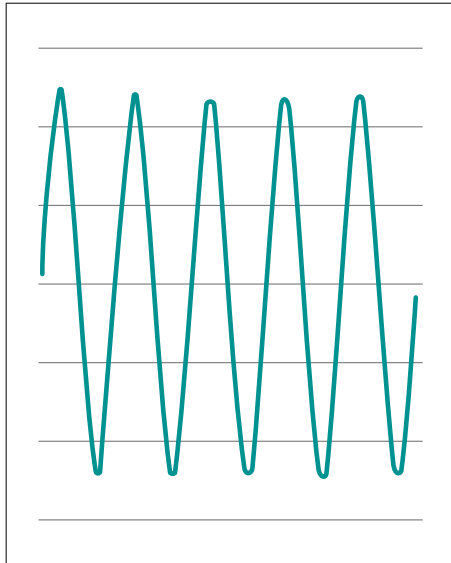
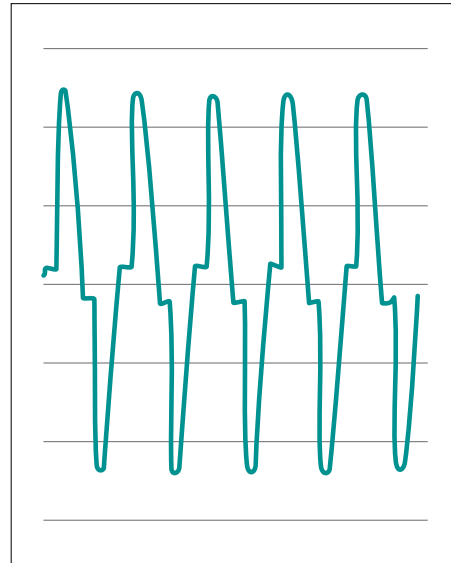
 **$I_{load} \leq I_{limit\ set}$**  **$I_{load} > I_{limit\ set}$** 

Set the maximum percent of the nominal current the power control allows. This parameter is in RMS current by default, but can be set to limit peak current.

Range: 0 to 100% - where 100% is the Unit Current Size

Default: 100%

Example: For the code RC3-11H\_\_\_\_\_ 100% = 1100A

### 15.1 Current Limit Setting

The setting of the current limit value can be done in two ways: Digital or Analogic.

- **Digital:** Set the parameter from the hardware menu  
Set the current limit value by the parameter . from 0 to 100% of the Current. (Operator menu)
- **Analogic:** Set the parameter from the hardware menu  
The value of the Current Limit is setted with analog input 2 Terminals 11 (-) e 4 (+).

**This analog input is 0 – 10V and input impedance 10Kohm.**

The settings functions by the analogic input 2 is called also External current limit profile because allows to change the profile of the Current Limit during the process.



**Caution: this procedure must be performed only by qualified persons.**

## 15.2 Current Limit tuning procedure

- Give the power supply and set the current limit to zero:
  - In analog mode, set the analog input 2 to zero
  - In digital mode, set the parameter=0
- Start the thyristor unit.
- Set the primary input or the setpoint value at 100%
- Increase the current limit
  - In analog mode increase the value of the analog input
  - In digital mode increase the parameter until to reach the desired value of rms current.
- Stop the thyristor unit.

The Current Limit Procedure is done.

Use the configurator software to set the desired current limit value.

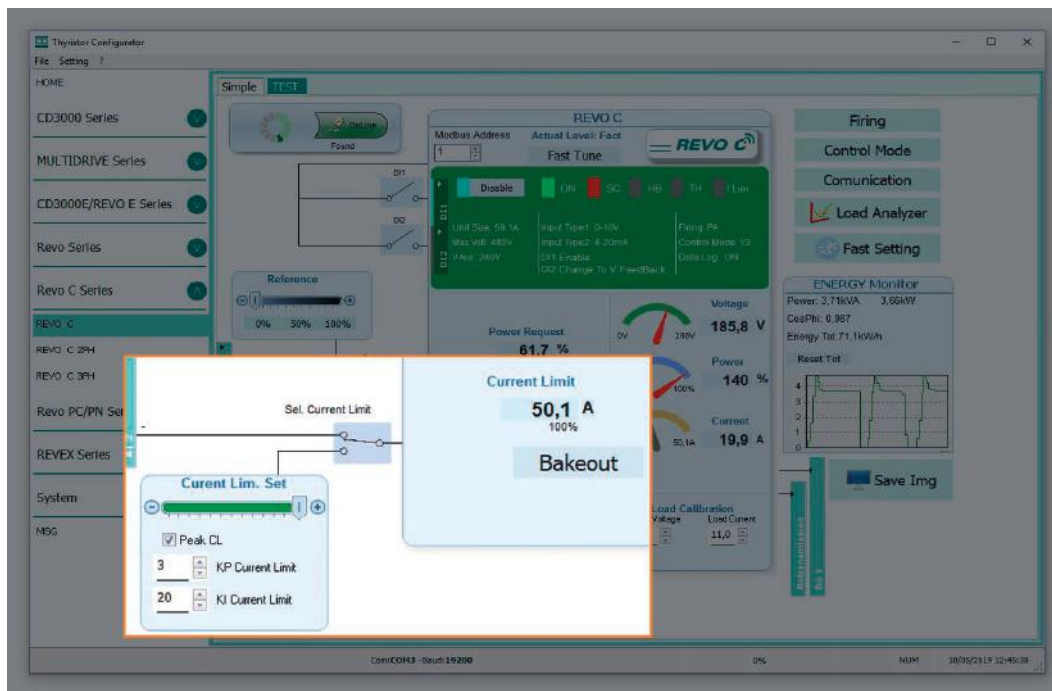

## 16

## Heater bakeout function

When a heater insulated with magnesium oxide (MgO) is powered off, not in use or in storage for a long period of time, it can absorb moisture. If full power is applied, excessive current can damage the heater or blow fuses. The heater bakeout feature limits the voltage and current applied as the heater is brought back in to service. This drives moisture out of the heater and prevents blown fuses and damage to the heater.

### 16.1 Using Heater Bakeout

While the heater bakeout feature is active, the REVO C power controller ramps the current according to the user-set current and ramp time parameters for the heater bakeout function. The heater bakeout function does not ramp the output above the normal process set point. Once the function has run for the user-set time, the bakeout function terminates and the power controller attempts to perform control to set point normally.

Use Heater Bakeout Ramp Time to set the duration of the bakeout in minutes. Use Heater Bakeout Current to set the current to which the function attempts to ramp in Amperes. Use Heater Bakeout Off Time to set how many minutes the heater can be off before the bakeout function runs the next time the heater is used.

While performing the heater bakeout function, the power controller displays a message.

Heater bakeout Indication

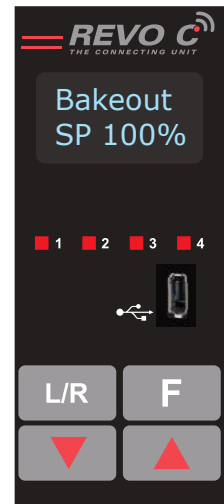

## 17

## Control Mode (feed-back)

The Control Mode (feed-back) type has already configured in line with customer requirements that are defined in the Order Code. The Order Code is written on the identification label.

However, if you wish to change the Control Mode (feed-back) type you can use the software configurator or the Control Panel.



**Caution: this procedure must be performed only by qualified persons.**

The Control Mode (feed-back) type is defined by the parameter Control Mode (feed-back) in setup menu. If the configurable digital input has set like feed-back Selection, it's possible to change the select feed-back with the Voltage feed-back (V) simply activating the input.

It's possible to have:

 **V<sup>2</sup>** = Square Voltage feed-back.

The input signal is proportional to the output square voltage. This means that input signal becomes a power demand. The power remains constant if the load impedance doesn't change.

 **V** = Voltage feed-back.

The input signal is proportional to the output voltage. This means that input signal becomes a voltage demand. This control mode compensates the voltage fluctuation of the incoming line supply.

 **I** = Current feed-back.

The input signal is proportional to the current output. This means that input signal becomes a current demand. This control mode maintain the current also if the load impedance changes.

 **P(VxI)** = Power feed-back.

The input signal is proportional to the power output. This means that input signal becomes a power demand. The power remains constant also if voltage and load impedance change. This control mode is used with silicon carbide elements that change its resistive value with temperature and with age. In addition it compensates the voltage fluctuation of the incoming line supply.

 **I<sup>2</sup>** = Square Current feed-back.

The input signal is proportional to the output square current. This kind of feedback is suggested for cold resistance applications.

 **None** = No feed-back Open Loop. The input is proportional to the firing angle ( $\alpha$ ).

 **External** = External feed-back (0÷10V, 4÷20mA, 0÷20mA).

The input signal is proportional to an external signal. This means that input signal becomes a demand to maintain this signal always constant. This control mode is used for example with galvanic systems, where it's necessary to control the current value through the electrodes.

# 18 Phase: access and substitution

Each phase can be substituted by front unit removing only 4/8 screws without the help of fork lift.

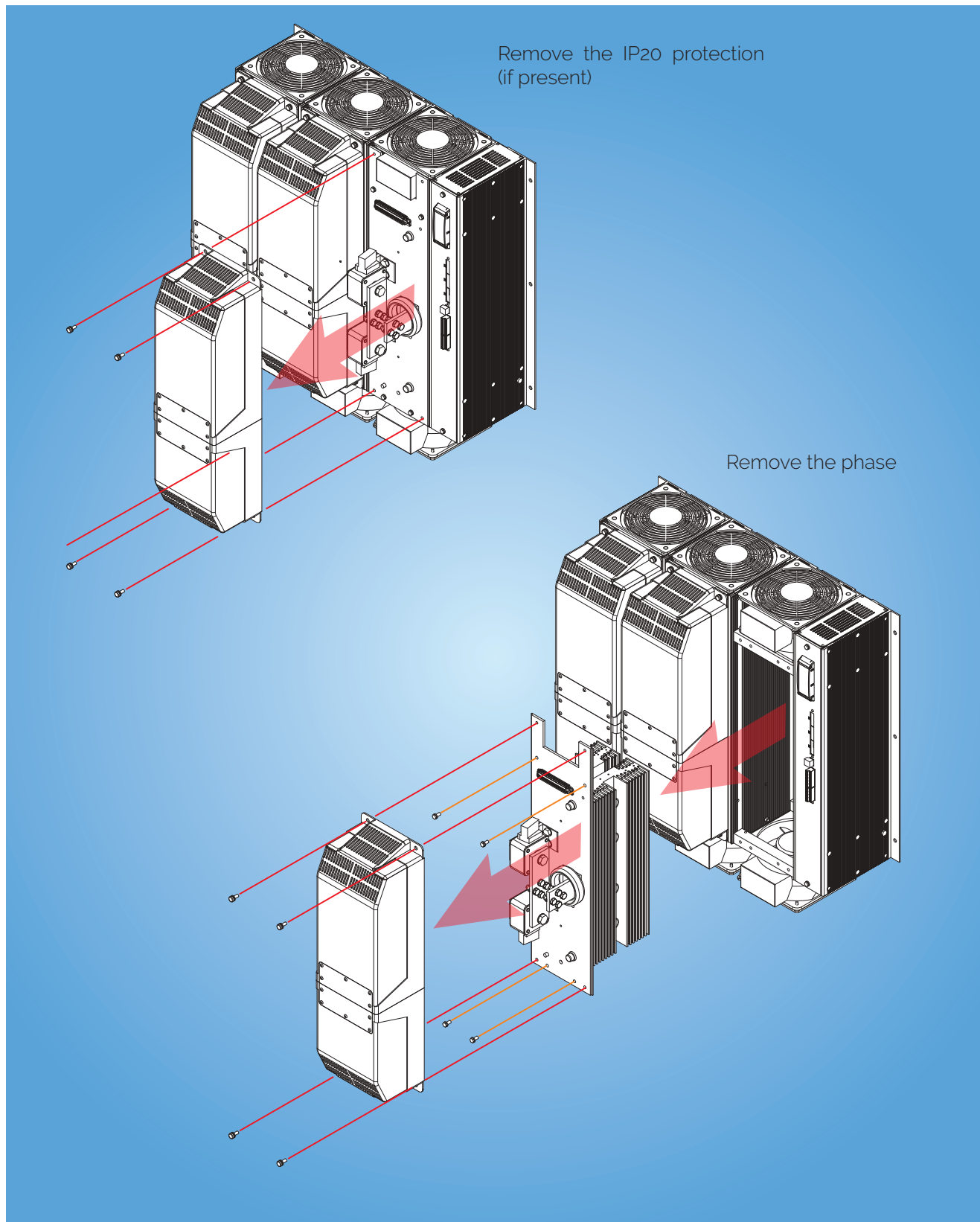



## 19

**Electronic Board: access and substitution**

Remove the connectors, unscrew the two M6 screws as shown in picture, and pull out the board with the support.

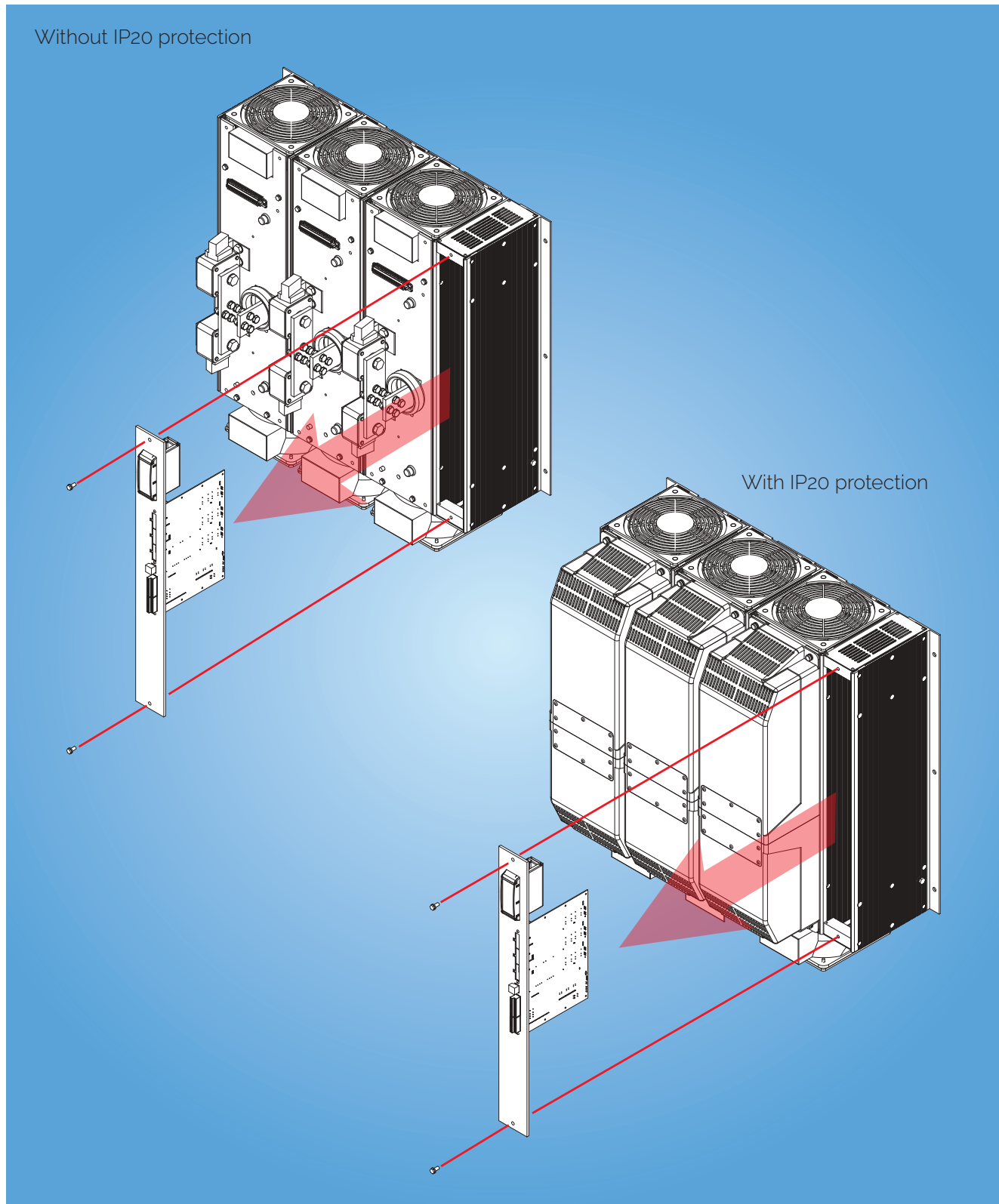



# 20 Supply the Electronic Board

The REVO C thyristor unit, to work, requires a voltage supply for the electronic boards. The Max consumption is 10VA.

The voltage supply for the electronic boards is configured in line with customer requirements that are defined in the Order Code. The Order Code is written on the identification label.



- **Warning:** Before connecting or disconnecting the unit check that power and control cables are isolated from voltage sources.
- **Specialised personnel only**

Terminal M4	Description
1	Voltage Supply for Electronic Boards (Auxiliary Voltage)
2	Not Used
3	Voltage Supply for Electronic Boards (Auxiliary Voltage)

If it is necessary to change the value of the auxiliary supply voltage, move the jumpers as shown in the table below.

The range of the auxiliary voltage that can be set depends on the transformer mounted on the board, see the ordering code on Digit 8 (see table).

Order Code	As ordered		Change to	
	Jumper JP1 + JP2 are linked		Link only Jumper JP3	
	Transformer range	Line voltage	Transformer range	Line voltage
RC3_ _ _ _ <b>1</b>	90:135V	100/120V		
RC3_ _ _ _ <b>2</b>			180:265V	200/208/220/230/240V

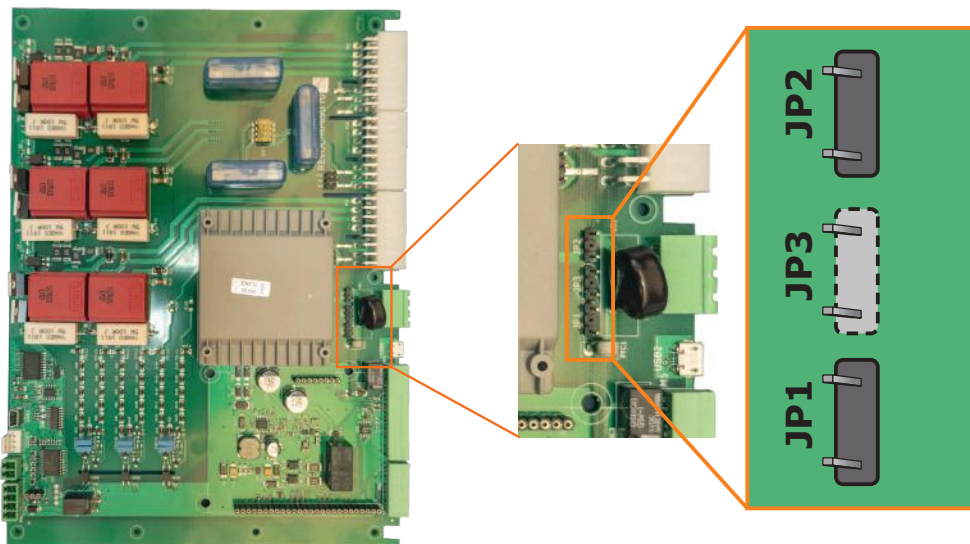

- **Attention!** never link all the jumpers JP1+JP2+JP3 at the same time or JP3 + any other jumper, JP3 must be always alone, follow only the configuration shown.
- Once the position of the jumpers has been changed, write the correct value in Par P43 (see next page).
- **Attention!** The auxiliary voltage is also used for firing synchronism, so it must be in phase with the load voltage.

### Sequence for writing the Aux Voltage value:

Click on 'Actual Level' and enter the password '1234' to access level 4.

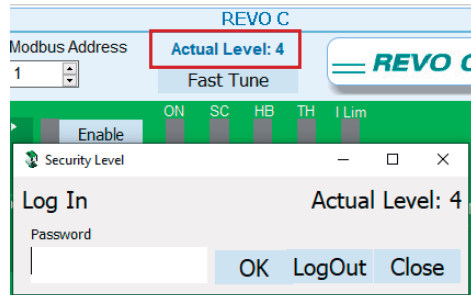

Click on the 'Fast Tune' button

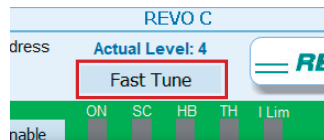

Enter the voltage value in the 'AuxVoltage' field, press enter.



## 20.1 Fuse Board protection

The main board is protected with fuses.

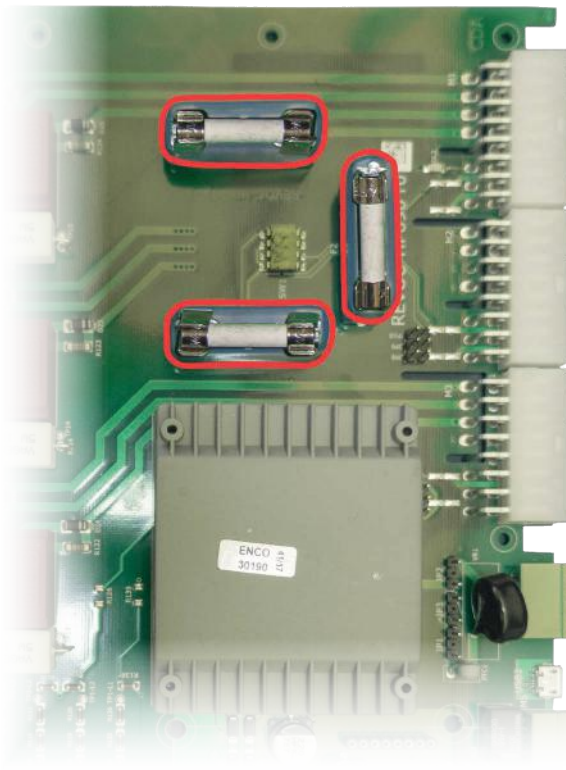

## 21 24Vdc input Auxiliary supplemental power (option)

The 24Vdc Auxiliary Supply input in Terminal Block M6, terminals 1 and 2, can be used as an auxiliary power supply when the main network fails. This auxiliary power supply keeps the communication circuits powered allowing data to be transferred to the supervision system.

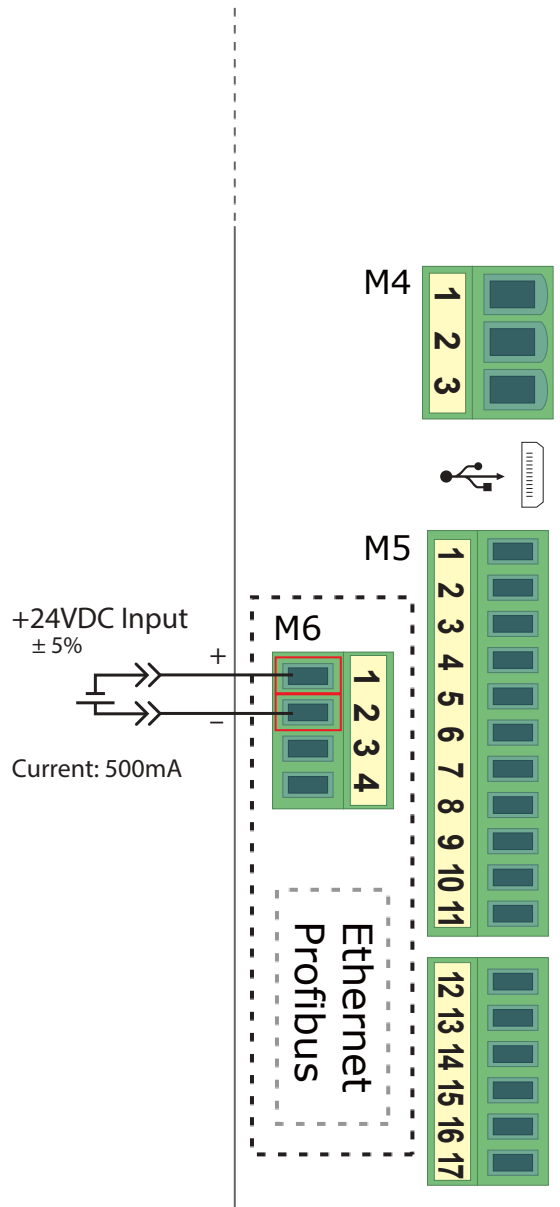

## 22 RS485 Serial port

The serial communication port RS485 is available on the Command Terminals. On this port may be done a network up to 127 REVO C.

Terminal M5	Description
7	RS485 A+
8	RS485 B-

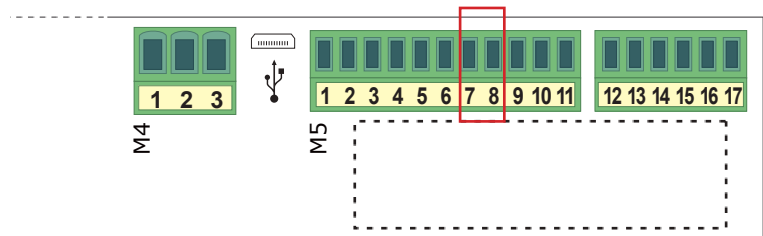

## 23 Fieldbus communication option

Other serial communication port are available as option, see Communication Manual for details.

### Profibus configuration connectors

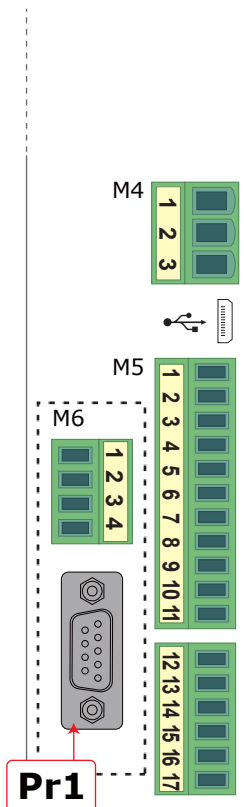

### Ethernet configuration connectors

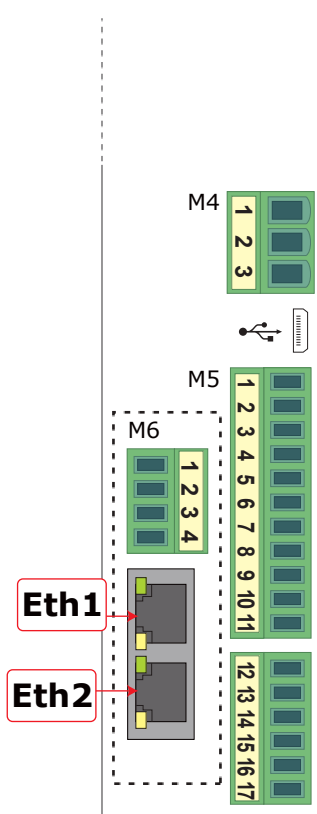

**Caution:** If Bus port is not connected or in error, all writable parameters are set to 0 value

# 24 Internal Fuse

The thyristor unit have internal fuse extrarapid at low I<sup>2</sup>T for the thyristor protection of against the short-circuits. The Fuses must have I<sup>2</sup>T 20% less than thyristor's I<sup>2</sup>T. The warranty of thyristor is null if no proper fuses are used.

Remove cover, remove screws and fuses.

**TORQUE for M12 fuse screws min: 32 Nm to Max: 52 Nm**

## 600V

Thyristor Size	Fuse CODE	200 kA <sub>RMS</sub> Symmetrical A.I.C.				Qty for each Phase
		Total Current (A <sub>RMS</sub> )	Power Loss (W)	FUSE I <sup>2</sup> T value Suggested A2s (at 660V)*	Vac	
1100A	FU800SIBSQB3690700V	800	118	480.000	690	2
1400A	FU1250SIBSQB3690700V	1250	147	1.750.000	690	2
1600A	FU1400SIBSQB3690700V	1400	161	2.200.000	690	2
1800A	FU1400SIBSQB3690700V	1400	161	2.200.000	690	2
2100A	FU1600SIBSQB3 600V	1600	190	3.700.000	600	2

\*I<sup>2</sup>T are multiplied for K value in function of Vac at 500V K is equal to 0,7 (ex:480.000 X 0,7 = 336.000). At 660 Vac K is equal to 1.

## 690V

Thyristor Size	Fuse CODE	200 kA <sub>RMS</sub> Symmetrical A.I.C.				Qty for each Phase
		Total Current (A <sub>RMS</sub> )	Power Loss (W)	FUSE I <sup>2</sup> T value Suggested A2s (at 1000V)*	Vac	
1100A	FU1000SIBSQB31000V	1000	150	1.900.000	1000	2
1400A	FU1250SIBSQB3900V	1250	198	3.300.000	900	2
1600A	FU1400SIBSQB3900V	1250	210	3.900.000	900	2
1800A	FU1400SIBSQB3900V	1400	210	3.900.000	900	2
2100A	FU1400SIBSQB3900V	1400	210	3.900.000	900	2

\*I<sup>2</sup>T are multiplied for K value in function of Vac at 700V K is equal to 0,73 (ex: 1.900.000 X 0,73= 1.387.000). At 1000 Vac K is equal to 1.



**Caution:** High speed fuses are used only for the thyristor protection and can not be used to protect the installation.



**Caution:** The warranty of thyristor is null if no proper fuses are used. See tab.



**Warning:** When it is supply, the Thyristor unit is subject to dangerous voltage, don't open the Fuse-holder module and don't touch the electric equipments.

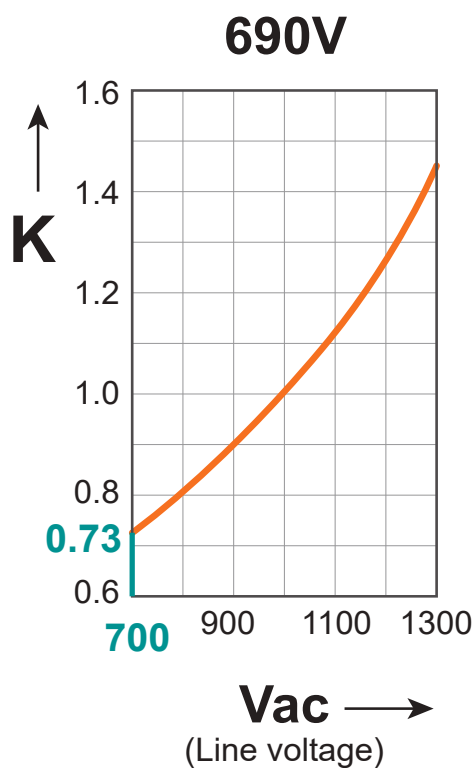
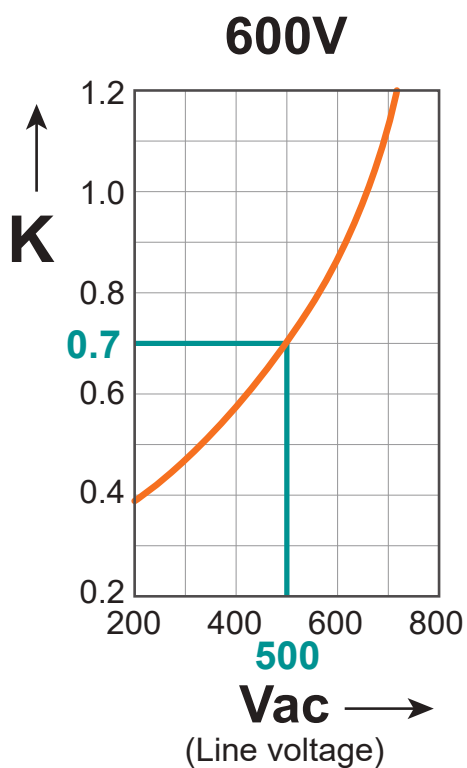



**CD Automation S.r.l.**

Via Picasso, 34/36 - 20025 Legnano (MI)- Italy

Tel. +39 0331 577479 - Fax +39 0331 579479

E-mail: [info@cdautomation.com](mailto:info@cdautomation.com) - Web: [www.cdautomation.com](http://www.cdautomation.com)